



# TEST REPORT

## Technical requirements for connection of power-generating plants to the low-voltage grid ( $\leq 1$ kV)

### Type A and B

<b>Report reference number</b> .....	<b>PVDK200917N006-8</b>
Date of issue .....	2021-02-05
Total number of pages .....	57
<b>Testing laboratory name</b> .....	<b>Bureau Veritas Shenzhen Co., Ltd. Dongguan Branch</b>
Address .....	No. 96, Guantai Road (Houjie Section), Houjie Town, Dongguan City, Guangdong Province, 523942, People's Republic of China
<b>Applicant's name</b> .....	<b>Shenzhen SOFARSOLAR Co., Ltd.</b>
Address .....	401, Building 4, AnTongDa Industrial Park, District 68, XingDong Community, XinAn Street, BaoAn District, Shenzhen, China
<b>Test specification</b>	
Standard.....	Technical requirements for connection of power-generating plants to the low-voltage grid ( $\leq 1$ kV) Type A and B, Version 1.2, 2019
Test Report Form No. ....	TR Type A and B VER.0
TRF Originator .....	Bureau Veritas Shenzhen Co., Ltd. Dongguan Branch
Master TRF .....	Dated 2020-08-22
<b>Test item description</b> .....	<b>Hybrid inverter</b>
Trademark.....	
Model / Type .....	HYD 3000-EP, HYD 3680-EP, HYD 4000-EP, HYD 4600-EP, HYD 5000-EP, HYD 5500-EP, HYD 6000-EP
<small>This report is governed by, and incorporates by reference, CPS Conditions of Service as posted at the date of issuance of this report at <a href="http://www.bureauveritas.com/home/about-us/our-business/cps/about-us/terms-conditions">http://www.bureauveritas.com/home/about-us/our-business/cps/about-us/terms-conditions</a> and is intended for your exclusive use. Any copying or replication of this report to or for any other person or entity, or use of our name or trademark, is permitted only with our prior written permission. This report sets forth our findings solely with respect to the test samples identified herein. The results set forth in this report are not indicative or representative of the quality or characteristics of the lot from which a test sample was taken or any similar or identical product unless specifically and expressly noted. Our report includes all of the tests requested by you and the results thereof based upon the information that you provided to us. Measurement uncertainty is only provided upon request for accredited tests. You have 60 days from date of issuance of this report to notify us of any material error or omission caused by our negligence or if you require measurement uncertainty; provided, however, that such notice shall be in writing and shall specifically address the issue you wish to raise. A failure to raise such issue within the prescribed time shall constitute your unqualified acceptance of the completeness of this report, the tests conducted and the correctness of the report contents.</small>	

<b>Ratings .....</b>	<b>HYD 3000-EP</b>	<b>HYD 3680-EP</b>	<b>HYD 4000-EP</b>
Full load MPP DC voltage range [V] :	160-520V	180-520V	200-520V
Input DC voltage range[V]..... :	90-600V		
Input DC current [A] .....	Max. 13A/13A		
Output AC voltage [V] .....	L/N/PE, 230Vac, 50Hz		
Output AC current [A]..... :	15,0	16,0	20,0
Output power [W] .....	3000	3680	4000
Max. output power [VA]..... :	3300	3680	4400
Output DC voltage range [V]..... : [Battery charge]..... :	42-58V		
Input/Output DC current [A]..... : [Battery charge/discharge] .....	Max. 75A	Max. 80A	Max. 85A
Charge and discharge power[W] .....	Max. 3750	Max. 4000	Max. 4250
Output AC voltage [V] .....	L/N/PE, 230Vac, 50Hz		
Max. Input/Output AC current [A]..... : [Battery charge/discharge mode ] .....	13,6	16,0	18,2
Max. Input/Output AC power [VA]..... : [Battery charge/discharge mode ] .....	3000	3680	4000
<b>Ratings .....</b>	<b>HYD 4600-EP</b>	<b>HYD 5000-EP</b>	<b>HYD 5500-EP</b>
Full load MPP DC voltage range [V] :	230-520V	250-520V	250-520V
Input DC voltage range[V]..... :	90-600V		
Input DC current [A] .....	Max. 13A/13A		
Output AC voltage [V] .....	L/N/PE, 230Vac, 50Hz		
Output AC current [A]..... :	20,9	21,7	25,0
Output power [W] .....	4600	5000	5000
Max. output power [VA]..... :	4600	5000	5500
Output DC voltage range [V]..... : [Battery charge]..... :	42-58V		
Input/Output DC current [A]..... : [Battery charge/discharge] .....	Max. 100A		
Charge and discharge power[W] .....	Max. 5000		
Output AC voltage [V] .....	L/N/PE, 230Vac, 50Hz		
Max. Input/Output AC current [A]..... : [Battery charge/discharge mode ] .....	20,9	22,7	22,7
Max. Input/Output AC power [VA]..... : [Battery charge/discharge mode ] .....	4600	5000	5000

<b>Ratings .....</b>	<b>HYD 6000-EP</b>
Full load MPP DC voltage range [V] :	300-520V
Input DC voltage range[V]..... :	90-600V
Input DC current [A] .....	Max. 13A/13A
Output AC voltage [V] .....	L/N/PE, 230Vac, 50Hz
Output AC current [A]..... :	27,3
Output power [W] .....	6000
Max. output power [VA]..... :	6000
Output DC voltage range [V]..... :	42-58V
[Battery charge]..... :	
Input/Output DC current [A]..... :	Max. 100A
[Battery charge/discharge] .....	
Charge and discharge power[W] .....	Max. 5000
Output AC voltage [V] .....	L/N/PE, 230Vac, 50Hz
Max. Input/Output AC current [A]..... :	22,7
[Battery charge/discharge mode ] .... :	
Max. Input/Output AC power [VA]..... :	5000
[Battery charge/discharge mode ] .... :	



**Testing Location.....: Bureau Veritas Shenzhen Co., Ltd. Dongguan Branch**  
Address .....: No. 96, Guantai Road (Houjie Section), Houjie Town, Dongguan City, Guangdong Province, 523942, People's Republic of China

Tested by  
(name and signature) .....: Lukes Lin

Approved by  
(name and signature) .....: James Huang

**Manufacturer's name .....: Shenzhen SOFARSOLAR Co., Ltd.**  
Manufacturer address .....: 401, Building 4, AnTongDa Industrial Park, District 68, XingDong Community, XinAn Street, BaoAn District, Shenzhen, China

**Factory's name .....: Dongguan SOFAR SOLAR Co.,Ltd.**  
Factory address.....: 1F - 6F, Building E, No. 1 JinQi Road, Bihu Industrial Park, Wulian Village, Fenggang Town, Dongguan City, Guangdong, China.



BUREAU  
VERITAS

Report No.: PVDK200917N006-8

<b>Document History</b>			
<b>Date</b>	<b>Internal reference</b>	<b>Modification / Change / Status</b>	<b>Revision</b>
2021-02-05	Lukes Lin	Initial report was written	0
Supplementary information:			

**Test items particulars**

Equipment mobility ..... : Permanent connection  
 Operating condition ..... : Continuous  
 Class of equipment ..... : Class I  
 Protection against ingress of water .. : IP65 according to EN 60529  
 Mass of equipment [kg] ..... : Approx. 21.5kg

**Test case verdicts**

Test case does not apply  
 to the test object ..... : N/A  
 Test item does meet  
 the requirement ..... : P(ass)  
 Test item does not meet  
 the requirement ..... : F(ail)

**Testing**

Date of receipt of test item ..... : 2020-03-02  
 Date(s) of performance of test ..... : 2020-03-02 to 2021-02-01

**General remarks:**

The test result presented in this report relate only to the object(s) tested. This report shall not be reproduced in part or in full without the written approval of the issuing testing laboratory.

"(see Annex #)" refers to additional information appended to the report.

"(see appended table)" refers to a table appended to the report.

Throughout this report a comma is used as the decimal separator.

**This Test Report consists of the following documents:**

1. Test Report
2. Annex No. 1 – Pictures of the unit
3. Annex No. 2 – Test equipment list

Copy of marking plate

<b>SOFAR SOLAR</b> Hybrid Inverter	
<b>Model No:</b>	<b>HYD 3000-EP</b>
Max. DC Input Voltage	600V
Operating MPPT Voltage Range	90V~580V
MAX. PV Isc	2x18A
Battery Type	Lead-acid, Lithium-ion
Battery Voltage Range	42-58V
Max. Charging Current	75A
Max. Discharging Current	75A
Max. Charging&Discharging Power	3750W
Nominal Grid Voltage	230Vac
Nominal Output Voltage	230Vac
Max. Output Current	15.0A
Nominal Grid Frequency	50/60Hz
Power Factor	1(adjustable+/-0.8)
Nominal Output Power	3000W
Backup Rated Current	13.6A
Backup Rated Apparent Power	3000VA
Ingress Protection	IP 65
Operating Temperature Range	-30~+60°C
Protective Class	Class I
Manufacturer : Shenzhen SOFARSOLAR Co., Ltd. Address : 401, Building 4, An TongDa Industrial Park, District 68, XingDong Community, XinAn Street, BaoAn District, Shenzhen, China VDE0126-1-1, VDE-AR-N4105 G98, AS4777, UTE C15-712-1	
	

<b>SOFAR SOLAR</b> Hybrid Inverter	
<b>Model No:</b>	<b>HYD 3680-EP</b>
Max. DC Input Voltage	600V
Operating MPPT Voltage Range	90V~580V
MAX. PV Isc	2x18A
Battery Type	Lead-acid, Lithium-ion
Battery Voltage Range	42-58V
Max. Charging Current	80A
Max. Discharging Current	80A
Max. Charging&Discharging Power	4000W
Nominal Grid Voltage	230Vac
Nominal Output Voltage	230Vac
Max. Output Current	16.0A
Nominal Grid Frequency	50/60Hz
Power Factor	1(adjustable+/-0.8)
Nominal Output Power	3680W
Backup Rated Current	16.0A
Backup Rated Apparent Power	3680VA
Ingress Protection	IP 65
Operating Temperature Range	-30~+60°C
Protective Class	Class I
Manufacturer : Shenzhen SOFARSOLAR Co., Ltd. Address : 401, Building 4, An TongDa Industrial Park, District 68, XingDong Community, XinAn Street, BaoAn District, Shenzhen, China VDE0126-1-1, VDE-AR-N4105 G98, AS4777, UTE C15-712-1	
	

<b>SOFAR SOLAR</b> Hybrid Inverter	
<b>Model No:</b>	<b>HYD 4000-EP</b>
Max. DC Input Voltage	600V
Operating MPPT Voltage Range	90V~580V
MAX. PV Isc	2x18A
Battery Type	Lead-acid, Lithium-ion
Battery Voltage Range	42-58V
Max. Charging Current	85A
Max. Discharging Current	85A
Max. Charging&Discharging Power	4250W
Nominal Grid Voltage	230Vac
Nominal Output Voltage	230Vac
Max. Output Current	20.0A
Nominal Grid Frequency	50/60Hz
Power Factor	1(adjustable+/-0.8)
Nominal Output Power	4000W
Backup Rated Current	18.2A
Backup Rated Apparent Power	4000VA
Ingress Protection	IP 65
Operating Temperature Range	-30~+60°C
Protective Class	Class I
Manufacturer : Shenzhen SOFARSOLAR Co., Ltd. Address : 401, Building 4, An TongDa Industrial Park, District 68, XingDong Community, XinAn Street, BaoAn District, Shenzhen, China VDE0126-1-1, VDE-AR-N4105 G98, AS4777, UTE C15-712-1	
	

<b>SOFAR SOLAR</b> Hybrid Inverter	
<b>Model No:</b>	<b>HYD 4600-EP</b>
Max. DC Input Voltage	600V
Operating MPPT Voltage Range	90V~580V
MAX. PV Isc	2x18A
Battery Type	Lead-acid, Lithium-ion
Battery Voltage Range	42-58V
Max. Charging Current	100A
Max. Discharging Current	100A
Max. Charging&Discharging Power	5000W
Nominal Grid Voltage	230Vac
Nominal Output Voltage	230Vac
Max. Output Current	20.9A
Nominal Grid Frequency	50/60Hz
Power Factor	1(adjustable+/-0.8)
Nominal Output Power	4600W
Backup Rated Current	20.9A
Backup Rated Apparent Power	4600VA
Ingress Protection	IP 65
Operating Temperature Range	-30~+60°C
Protective Class	Class I
Manufacturer : Shenzhen SOFARSOLAR Co., Ltd. Address : 401, Building 4, An TongDa Industrial Park, District 68, XingDong Community, XinAn Street, BaoAn District, Shenzhen, China VDE0126-1-1, VDE-AR-N4105 G98, AS4777, UTE C15-712-1	
	



Copy of marking plate

<b>SOFAR SOLAR</b> Hybrid Inverter	
<b>Model No:</b>	<b>HYD 5000-EP</b>
Max. DC Input Voltage	600V
Operating MPPT Voltage Range	90V~580V
MAX. PV Isc	2x18A
Battery Type	Lead-acid, Lithium-ion
Battery Voltage Range	42-58V
Max. Charging Current	100A
Max. Discharging Current	100A
Max. Charging & Discharging Power	5000W
Nominal Grid Voltage	230Vac
Nominal Output Voltage	230Vac
Max. Output Current	21.7A
Nominal Grid Frequency	50/60Hz
Power Factor	1 (adjustable +/-0.8)
Nominal Output Power	5000W
Backup Rated Current	22.7A
Backup Rated Apparent Power	5000VA
Ingress Protection	IP 65
Operating Temperature Range	-30~+60°C
Protective Class	Class I
Manufacturer : Shenzhen SOFARSOLAR Co., Ltd. Address : 401, Building 4, An TongDa Industrial Park, District 68, XingDong Community, XinAn Street, BaoAn District, Shenzhen, China VDE0126-1-1, VDE-AR-N4105 G98, AS4777, UTE C15-712-1	

<b>SOFAR SOLAR</b> Hybrid Inverter	
<b>Model No:</b>	<b>HYD 5500-EP</b>
Max. DC Input Voltage	600V
Operating MPPT Voltage Range	90V~580V
MAX. PV Isc	2x18A
Battery Type	Lead-acid, Lithium-ion
Battery Voltage Range	42-58V
Max. Charging Current	100A
Max. Discharging Current	100A
Max. Charging & Discharging Power	5000W
Nominal Grid Voltage	230Vac
Nominal Output Voltage	230Vac
Max. Output Current	25.0A
Nominal Grid Frequency	50/60Hz
Power Factor	1 (adjustable +/-0.8)
Nominal Output Power	5000W
Backup Rated Current	22.7A
Backup Rated Apparent Power	5000VA
Ingress Protection	IP 65
Operating Temperature Range	-30~+60°C
Protective Class	Class I
Manufacturer : Shenzhen SOFARSOLAR Co., Ltd. Address : 401, Building 4, An TongDa Industrial Park, District 68, XingDong Community, XinAn Street, BaoAn District, Shenzhen, China VDE0126-1-1, VDE-AR-N4105 G98, AS4777, UTE C15-712-1	

<b>SOFAR SOLAR</b> Hybrid Inverter	
<b>Model No:</b>	<b>HYD 6000-EP</b>
Max. DC Input Voltage	600V
Operating MPPT Voltage Range	90V~580V
MAX. PV Isc	2x18A
Battery Type	Lead-acid, Lithium-ion
Battery Voltage Range	42-58V
Max. Charging Current	100A
Max. Discharging Current	100A
Max. Charging & Discharging Power	5000W
Nominal Grid Voltage	230Vac
Nominal Output Voltage	230Vac
Max. Output Current	27.3A
Nominal Grid Frequency	50/60Hz
Power Factor	1 (adjustable +/-0.8)
Nominal Output Power	6000W
Backup Rated Current	22.7A
Backup Rated Apparent Power	5000VA
Ingress Protection	IP 65
Operating Temperature Range	-30~+60°C
Protective Class	Class I
Manufacturer : Shenzhen SOFARSOLAR Co., Ltd. Address : 401, Building 4, An TongDa Industrial Park, District 68, XingDong Community, XinAn Street, BaoAn District, Shenzhen, China VDE0126-1-1, VDE-AR-N4105 G98, AS4777, UTE C15-712-1	



**General product information:**

The inverter converts DC voltage, generated by photovoltaic modules, into AC voltage.  
The units are single-phases hybrid-inverter.  
Rate of change of frequency (RoCoF) detection was used for LOM protection.

The units are only for type A power-generating plants.

**Description of the power circuit (Figure 1):**

The charging current to batteries from PV array and grid, battery management unit is integrated in External Energy storage.

The Solar converter is a single-phase type, only one machine is allowed on each line conductor and power capacity is allowed to less than 11,08kW while is parallel to power generation system

The unit is providing EMC filtering at the output toward mains. The unit does not provide galvanic separation from input to output (transformerless). The output is switched off redundant by the high power switching bridge and a two relays. This assures that the opening of the output circuit will also operate in case of one error.

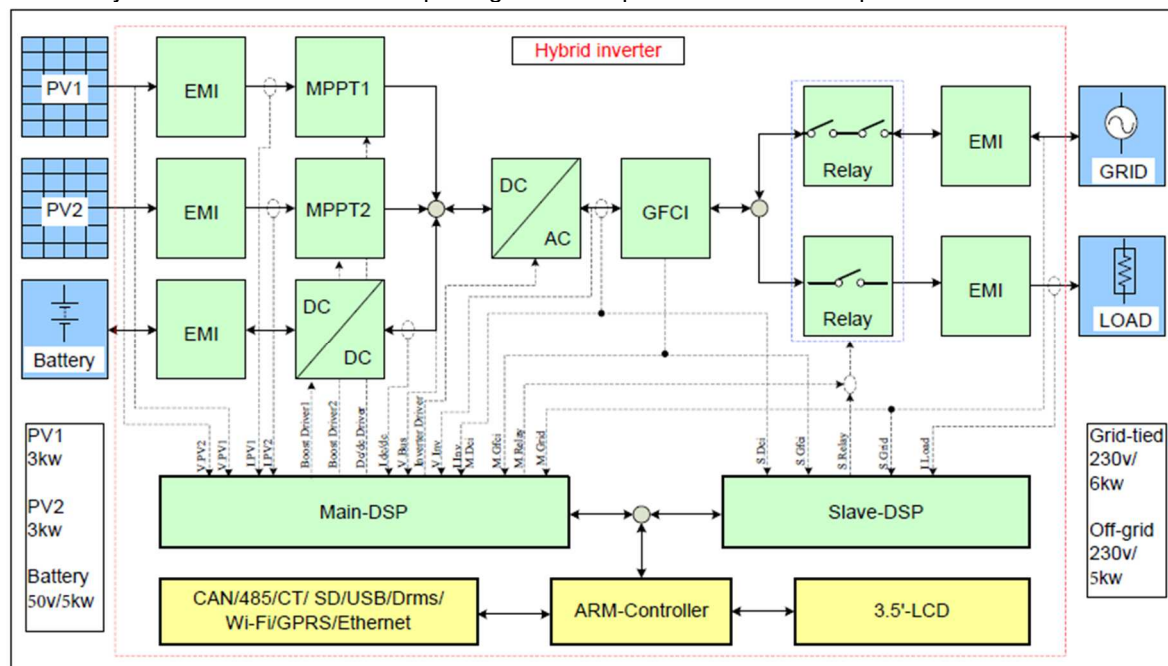

**Figure 1 – Block diagram**

The internal control is redundant built. It consists of Main MCU(U4) and slave MCU(U43).

The Main MCU(U4) can control the relays, measures voltage, and frequency, AC current with injected DC, insulation resistance and residual current, In addition it tests the array insulation resistance and the RCMU circuit before each start up.

The slave MCU (U43) is using for controlling the relays, measuring the voltage , frequency, inject a dc AC current, the residual current, and communicating with the master MCU (U4). And if the communicating with the master DSP, the slave DSP will disconnect the relays.

The unit provides two relays in series on Line and Neutral conductors. When single-fault applied to one relay, alarm an error code in display panel, another redundant relay provides basic insulation maintained between the PV array and the mains. All the relays are tested before start up. Both controllers Main MCU(U4), Slave MCU (U43) can open the relays.

**Differences of the models:**

The models HYD 3000-EP, HYD 3680-EP, HYD 4000-EP, HYD 4600-EP, HYD 5000-EP, HYD 5500-EP and HYD 6000-EP are completely identical and output power derated by software, except for the following table.

	HYD 3000-EP	HYD 3680-EP	HYD 4000-EP	HYD 4600-EP	HYD 5000-EP	HYD 5500-EP	HYD 6000-EP
R332, R334, R336	(NC, 0Ω, NC)			(0Ω, NC, 0Ω)			
Bus capacitance	6pcs			8pcs			
INV inductor	1,035mH			0,75mH			
R123, R132	(499Ω, 499Ω)			(1.5kΩ, 1.5kΩ)			

**The product was tested on:**

Hardware version: V001

Software version: V02000

### General remarks:

The test results presented in this report relate only to the object(s) tested.

This document may be published or passed on in full only. Extraction of parts needs the written permission of Bureau Veritas Consumer Products Services GmbH.

"(see Annex #)" refers to additional information appended to the report.

"(see appended table)" refers to a table appended to the report.

Throughout this report a comma is used as the decimal separator.

The following suffixes are used for variables in tables and figures:

- "P<sub>n</sub>" for the nominal active power:  
 $P_n = U_n \times I_n \times \cos \varphi_n$  (single-Phase);  $P_n = \sqrt{3} U_n \times I_n \times \cos \varphi_n$  (three-Phase)
- "P<sub>M</sub>" for the momentary power
- "(c)" for over-excited
- "(i)" for under-excited

### Active and reactive power:

The regarded system of the voltage and current vectors is the load view (Figure 2):

- If the inverter feeds to the grid the active power is measured with negative sign. For the sake of reading the document the measured active infeed power has a positive sign

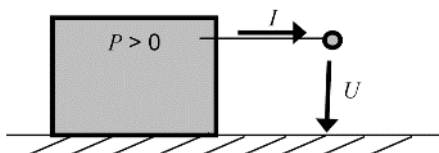

- If the inverter consumes inductive reactive power the reactive power is marked "inductive" or has a positive sign.
- If the inverter consumes capacitive reactive power the reactive power is marked "capacitive" or has a negative sign.

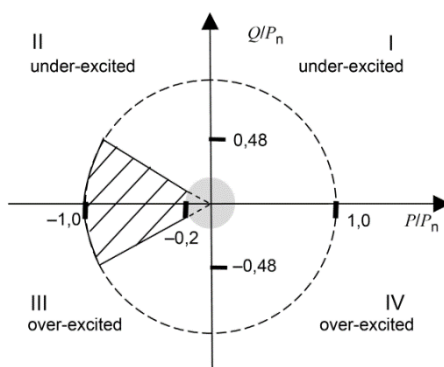

Figure 2

## TECHNICAL REGULATION

Clause	Test requirement (According to Appendix 1 and 2)	Result
4	Requirements for type A power-generating plants	P
5	Requirements for type B power-generating plants	N/A

## TECHNICAL REGULATION: Requirements for type A power-generating plants

Clause	Test requirement	Result
4.1	Immunity to frequency and voltage deviations	P
4.2	Start-up and reconnection of a power-generating plant	P
4.3	Active power control	P
4.4	Reactive power control	P
4.5	Protection	P
4.6	Power quality	P

4.1 Tolerance of frequency and voltage deviations				P
4.1.1 Normal operation				
4.1.3 Tolerance of voltage deviations				
Setting values	Over-voltage [V]:		253	
	Under-voltage [V]:		195,5	
	Over-frequency [Hz]:		51,5	
	Under-frequency [Hz]:		47,5	
<ul style="list-style-type: none"> <li>- Test 1: U = 195,5 V; f = 47,5 Hz; P = 1,00 S<sub>n</sub>; cosφ = 1</li> <li>- Test 2: U = 195,5 V; f = 48,5 Hz; P = 1,00 S<sub>n</sub>; cosφ = 1</li> <li>- Test 3: U = 253,0 V; f = 51,5 Hz; P = 1,00 S<sub>n</sub>; cosφ = 1</li> <li>- Test 4: U = 230,0 V; f = 50,0 Hz; Voltage Phase jumps Change +20 degrees P = 1,00 S<sub>n</sub>; cosφ = 1</li> <li>-</li> </ul>				
<b>Test result: HYD 6000-EP</b>				
Test sequence	Voltage [V]	Frequency [Hz]	Output power [kW]	Cos φ
Test1	195,36	47,50	5,949	0,9939
Test2	195,41	48,50	5,948	0,9977
Test3	253,72	51,50	6,032	0,9972
Test4	230,83	50,00	6,017	0,9995
<b>Note:</b>				
<p>Test method refer clause D.3.1 of EN 50438:2013.</p> <p>During the tests the interface protection was disabled.</p> <p>Operation at reduced power is allowed during test 1, equal to the maximum power that can be supplied on reaching the maximum output current limit (<math>P \geq 0,85 S_n</math>).</p> <p>During the sequence of test 3, automatic adjustment to reduce power in the case of over-frequency was disabled.</p> <p>The tests had been performed on the HYD 6000-EP is valid for the HYD 5500-EP, HYD 5000-EP, HYD 4600-EP, HYD 4000-EP, HYD 3680-EP and HYD 3000-EP, since it is identical in hardware and software construction except output power derated by software.</p>				



<b>4.1 Tolerance of frequency and voltage deviations</b>				<b>P</b>
<b>4.1.2 Tolerance of frequency deviations</b>				
<b>4.1.2.1 Frequency change</b>				
	<b>Start Frequency</b>	<b>Change</b>	<b>End Frequency</b>	<b>Confirm no trip</b>
Positive Frequency drift	49Hz	+2Hz/sec	51Hz	No trip
Negative Frequency drift	51Hz	-2Hz/sec	49Hz	No trip
<b>Note:</b>				
Test method refer clause A.7.1.2.6 of G99/1-4:2019.				
Hold for 10 s				
Manufacturers considering new designs should allow for the RoCoF where stability is required to be increased to, up to 2Hz per second, as proposed in the new European network codes, which are expected to come into force over the period 2014/2015. Under these conditions RoCoF will cease to be an effective loss of mains protection and is unlikely to be permitted in future revisions of this document.				
For the step change test the SSEG should be operated with a measureable output at the start frequency and then a vector shift should be applied by extending or reducing the time of a single cycle with subsequent cycles returning to the start frequency. The start frequency should then be maintained for a period of at least 10 seconds to complete the test. The SSEG should not trip during this test.				
For frequency drift tests the SSEG should be operated with a measureable output at the start frequency and then the frequency changed in a ramp function at 0,95Hz per second to the end frequency. On reaching the end frequency it should be maintained for a period of at least 10 seconds. The SSEG should not trip during this test.				
The tests had been performed on the HYD 6000-EP is valid for the HYD 5500-EP, HYD 5000-EP, HYD 4600-EP, HYD 4000-EP, HYD 3680-EP and HYD 3000-EP, since it is identical in hardware and software construction except output power derated by software.				

**4.1 Tolerance of frequency and voltage deviations**  
**4.1.2 Tolerance of frequency deviations**  
**4.1.2.2 Permitted reduction of active power during underfrequency**

**P**

**Graph of frequency a) to b) to c) to d) to e): HYD 6000-EP**

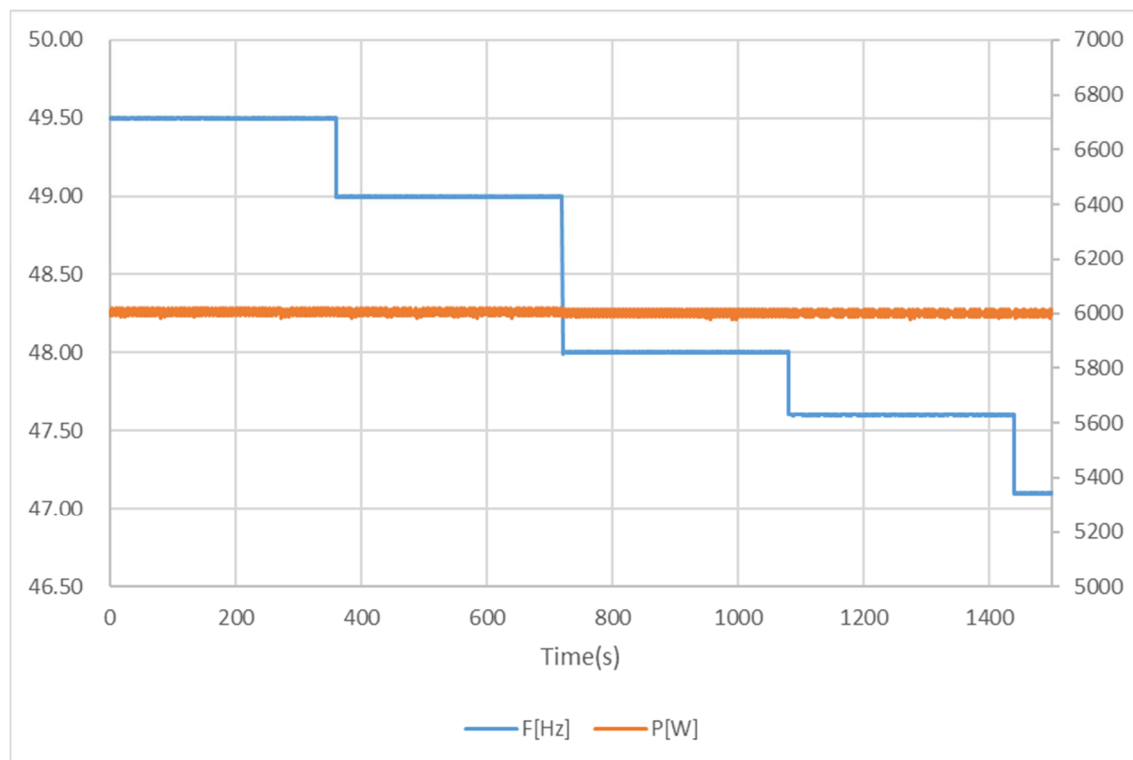

**Test result:**

	Switch to:				
5-min mean value (each)	a) 49,50 Hz	b) 49,00 Hz	c) 48,00 Hz	d) 47,60 Hz	e) 47,10 Hz
Frequency [Hz]:	49,50	49,00	48,00	47,60	47,10
Active power [kW]:	6,005	6,004	6,002	6,000	6,000
$\Delta P/P_n$ [%] :	0	0	0	0	0

**Assessment criterion:**

A power-generating plant is permitted to reduce the active power within the 49 Hz-47.5 Hz frequency range. In this range, it is permitted to reduce the active power by 6% of  $P_n/Hz$ .

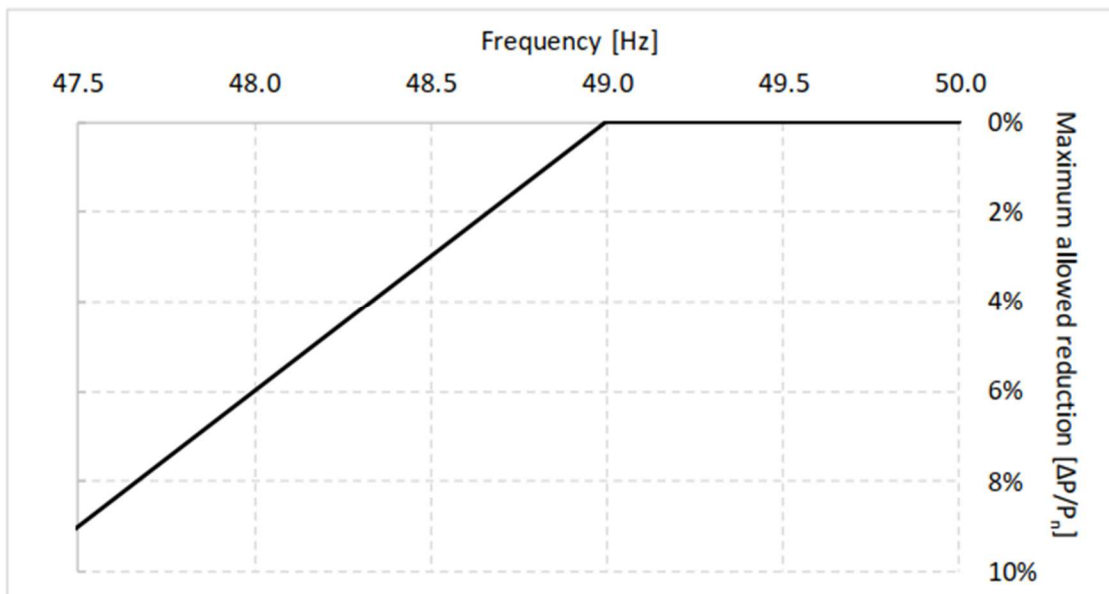

Maximum allowable power reduction in case of under-frequency

**Note:**

The tests had been performed on the HYD 6000-EP is valid for the HYD 5500-EP, HYD 5000-EP, HYD 4600-EP, HYD 4000-EP, HYD 3680-EP and HYD 3000-EP, since it is identical in hardware and software construction except output power derated by software.

4.2 Start-up and reconnction of a power-generating plant		P
Setting value	Min. voltage for connected to grid :	195,5
	Max. voltage for connected to grid :	253
	Min. frequency for connected to grid(DK1) :	47,5
	Min. frequency for connected to grid(DK2) :	47,5
	Max. frequency for connected to grid(DK1) :	50,2
	Max. frequency for connected to grid(DK2) :	50,5
	Observation time ( $\geq 180s$ ) :	180
<b>Test:</b>		
	<b>Voltage conditons</b>	
a) Start up for voltage range	<84% Un for twice of observation time	>110% Un for twice of observation time
Connection:	No connection	No connection
Limit	No connection allowed	
b) In voltage range at start-up	$\geq 85\%$ Un within twice setting observation time	$\leq 110\%$ Un within twice setting observation time
Reconnection time [s]	186	186
Limit:	Connected after setting observation time ( $\geq 180s$ )	
Gradient:	For adjustable micro generators the maximum occurring active power gradient after connection respectively start generating electrical power is less than the configured maximum active power per minute Max gradient: $20\%P_{Emax}/min.$	
c) In voltage range after voltage faulture	$\geq 85\%$ Un for twice of setting observation time	$\leq 110\%$ Un for twice of setting observation time
Reconnection time [s]	186	186
Limit:	Reconnection after setting observation time ( $\geq 180s$ )	
Gradient:	For adjustable micro generators the maximum occurring active power gradient after connection respectively start generating electrical power is less than the configured maximum active power per minute Max gradient: $20\%P_{Emax}/min.$ For recorded gradient see diagram below.	

<b>Frequency conditions</b>		
FSM band for DK1		
d) Start up for frequency range	<47,40 Hz for twice of setting observation time	>50,20 Hz for twice of setting observation time
Connection:	No connection	No connection
Limit	No connection allowed	
e) In frequency range at start-up	≥47,50 Hz within twice of setting observation time	≤50,20 Hz within twice of setting observation time
Reconnection time [s]	184	185
Limit:	Connected after setting delay time(≥180s)	
Gradient:	For adjustable micro generators the maximum occurring active power gradient after connection respectively start generating electrical power is less than the configured maximum active power per minute Max gradient: 20%P <sub>E<sub>max</sub></sub> /min.	
f) In frequency range after frequency failure	≥47,50 Hz for twice of setting observation time	≤50,20 Hz for twice of setting observation time
Reconnection time [s]	185	185
Limit:	Reconnection after setting observation time (≥180s)	
Gradient:	For adjustable micro generators the maximum occurring active power gradient after connection respectively start generating electrical power is less than the configured maximum active power per minute Max gradient: 20%P <sub>E<sub>max</sub></sub> /min. tion is delayed by a randomised value between 1 min and 10 min. For recorded gradient see diagram below.	

<b>Frequency conditions</b>		
FSM band for DK2		
d) Start up for frequency range	<47,40 Hz for twice of setting observation time	>50,60 Hz for twice of setting observation time
Connection:	No connection	No connection
Limit	No connection allowed	
e) In frequency range at start-up	≥47,50 Hz within twice of setting observation time	≤50,50 Hz within twice of setting observation time
Reconnection time [s]	184	185
Limit:	Connected after setting delay time(≥180s)	
Gradient:	For adjustable micro generators the maximum occurring active power gradient after connection respectively start generating electrical power is less than the configured maximum active power per minute Max gradient: 20%P <sub>E<sub>max</sub></sub> /min.	
f) In frequency range after frequency failure	≥47,50 Hz for twice of setting observation time	≤50,50 Hz for twice of setting observation time
Reconnection time [s]	185	185
Limit:	Reconnection after setting observation time (≥180s)	
Gradient:	For adjustable micro generators the maximum occurring active power gradient after connection respectively start generating electrical power is less than the configured maximum active power per minute Max gradient: 20%P <sub>E<sub>max</sub></sub> /min. tion is delayed by a randomised value between 1 min and 10 min. For recorded gradient see diagram below.	
<b>Test:</b> In order to avoid continuous starting and disengaging operations of the interface protection relay, the disengaging value of frequency and voltage functions shall be above 2 % deviating from the operate value.		
<b>Assessment criterion:</b> a) the micro generator connects respectively starts generating electrical power only in the permitted range of voltage and frequency and b) for adjustable micro generators the maximum occurring active power gradient after connection respectively start generating electrical power is less than the configured maximum active power per minute and		
<b>Note:</b> The tests had been performed on the HYD 6000-EP is valid for the HYD 5500-EP, HYD 5000-EP, HYD 4600-EP , HYD 4000-EP, HYD 3680-EP and HYD 3000-EP, since it is identical in hardware and software construction except output power derated by software.		



Graph of the gradual power supply :

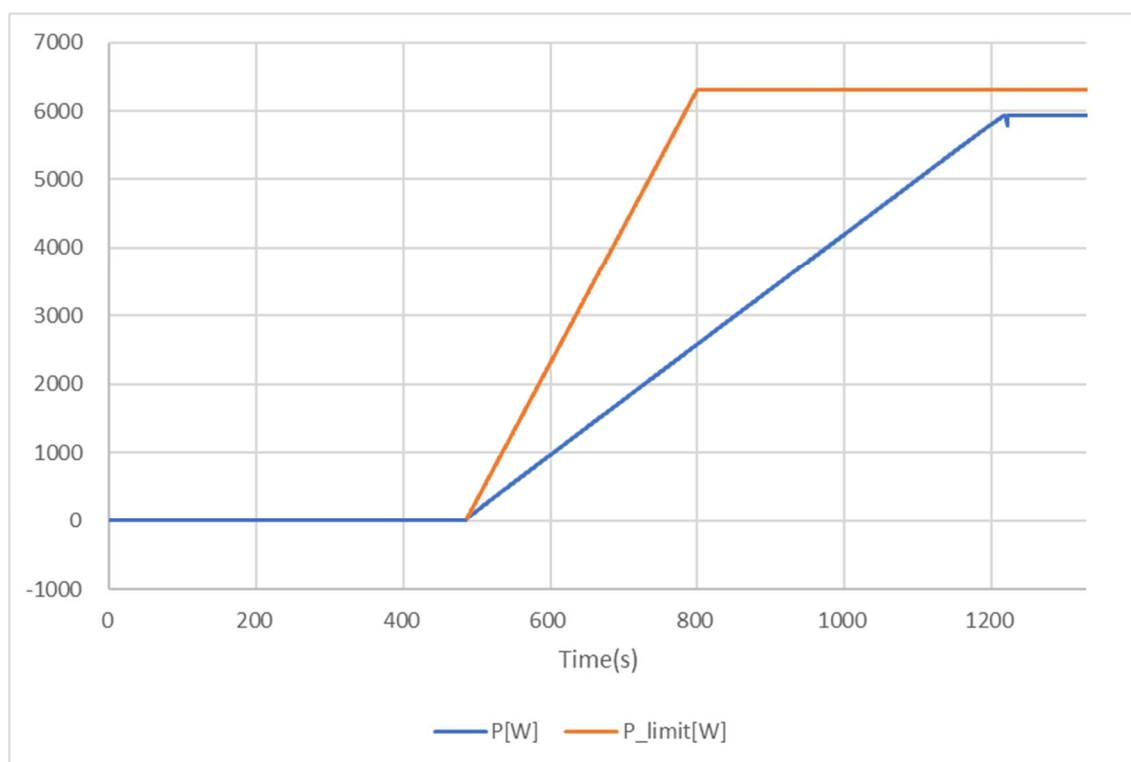

4.3 Active power control								P
<b>Test result: HYD 6000-EP</b>								
<b>Standard frequency response settings for DK1</b>								
1-min mean value [Hz]:	a) 50,00	b) 50,25	c) 50,70	d) 51,40	e) 50,70	f) 50,25	g) 50,00	
1. Measurement a) to g): Active power output =100% $P_{E_{max}}$ Droop=5% (40% $P_n$ / Hz), threshold frequency for start/return: 50,2Hz								
Frequency [Hz]:	50,00	50,25	50,70	51,40	50,70	50,25	50,00	
$P_M$ [kW]:	N/A	5,887	4,807	3,127	4,807	5,886	N/A	
$P_{E60}$ [kW]:	6,009	5,898	4,826	3,134	4,824	5,899	6,020	
$\Delta P_{E60}/P_M$ [%]:	N/A	0,19	0,32	0,11	0,29	0,22	N/A	
2. Measurement a) to g): Active power output 60% after freezing = 100% $P_{E_{max}}$ s=5% (40% $P_n$ / Hz), threshold frequency for start/return: 50,2Hz								
Frequency [Hz]:	50,00	50,25	50,70	51,40	50,70	50,25	50,00	
$P_M$ [kW]:	50,00	50,25	50,70	51,40	50,70	50,25	50,00	
$P_{E60}$ [kW]:	N/A	3,505	2,425	0,745	2,424	3,503	N/A	
$\Delta P_{E60}/P_M$ [%]:	3,625	3,500	2,430	0,777	2,430	3,500	6,019	
<b>Limit <math>\Delta P/P_{1min}</math>:</b>	$\pm 5\%$ of $P_{E_{max}}$							
<b>Standard frequency response settings for DK2</b>								
1-min mean value [Hz]:	a) 50,00	b) 50,55	c) 50,70	d) 51,40	e) 50,70	f) 50,55	g) 50,00	
1. Measurement a) to g): Active power output =100% $P_{E_{max}}$ s=4% (50% $P_n$ / Hz), threshold frequency for start/return: 50,5Hz								
Frequency [Hz]:	50,00	50,55	50,70	51,40	50,70	50,55	50,00	
$P_M$ [kW]:	50,00	50,55	50,70	51,40	50,70	50,55	50,00	
$P_{E60}$ [kW]:	N/A	5,840	5,390	3,290	5,390	5,840	N/A	
$\Delta P_{E60}/P_M$ [%]:	5,991	5,834	5,388	3,294	5,388	5,834	5,992	
2. Measurement a) to g): Active power output 60% after freezing = 100% $P_{E_{max}}$ s=4% (50% $P_n$ / Hz), threshold frequency for start/return: 50,5Hz								
Frequency [Hz]:	50,00	50,55	50,70	51,40	50,70	50,55	50,00	
$P_M$ [kW]:	N/A	3,450	3,000	0,900	3,000	3,450	N/A	
$P_{E60}$ [kW]:	3,601	3,461	3,020	0,942	3,019	3,461	5,991	
$\Delta P_{E60}/P_M$ [%]:	N/A	0,17	0,34	0,71	0,32	0,18	N/A	
<b>Limit <math>\Delta P/P_{1min}</math>:</b>	$\pm 5\%$ of $P_{E_{max}}$							

**Graph of Measurement 1.of DK1: Active power output > 80%  $P_{Emax}$**

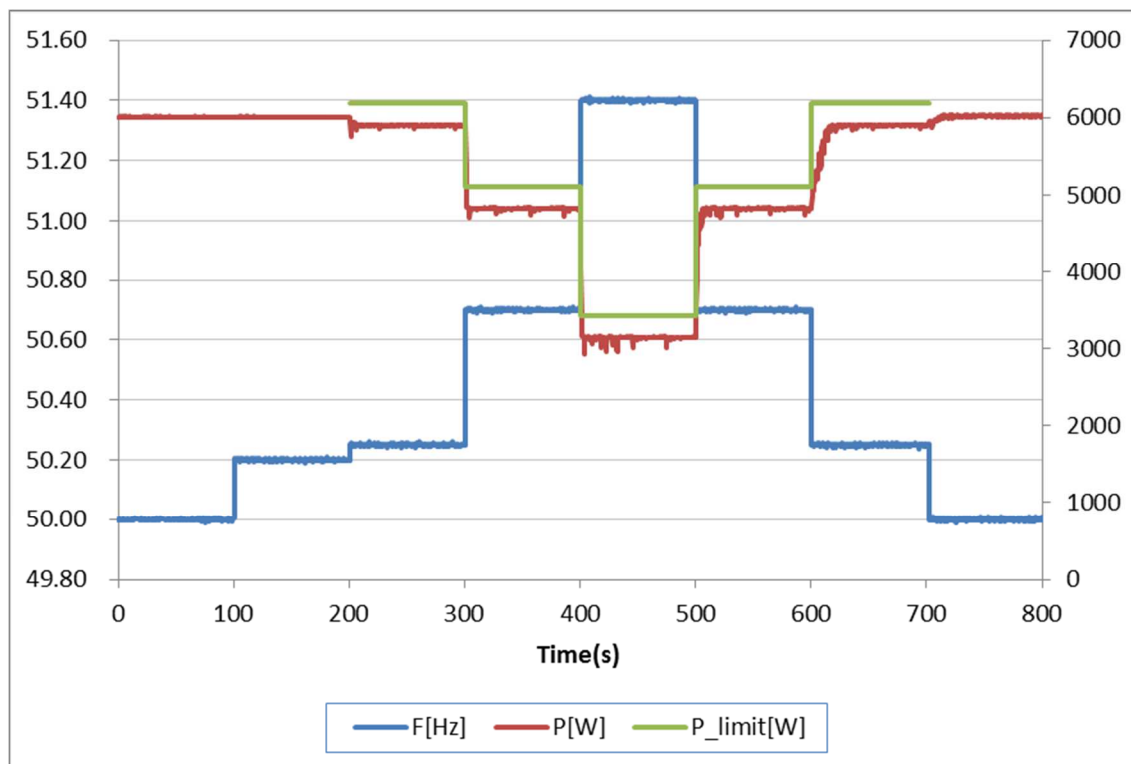

**Graph of Measurement 2 of DK1.:Active power output 40% and 60% after freezing > 80%  $P_n$**

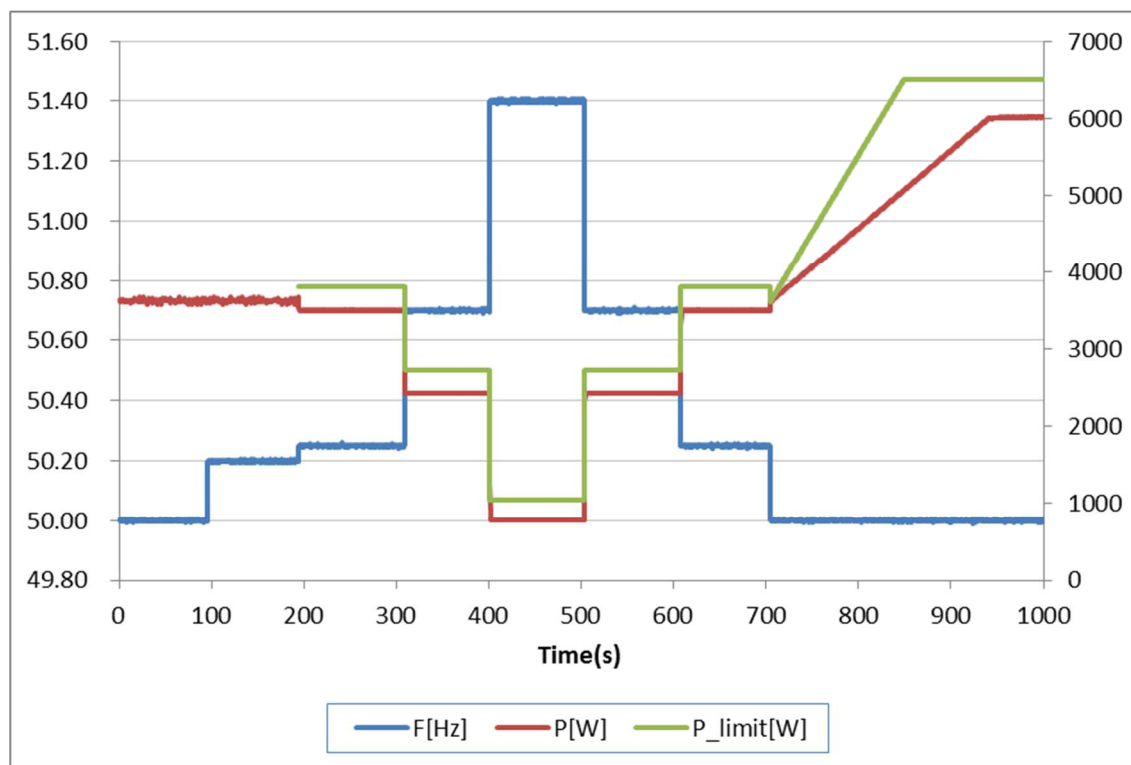

**Graph of Measurement 1.of DK2: Active power output > 80% P<sub>E</sub>max**

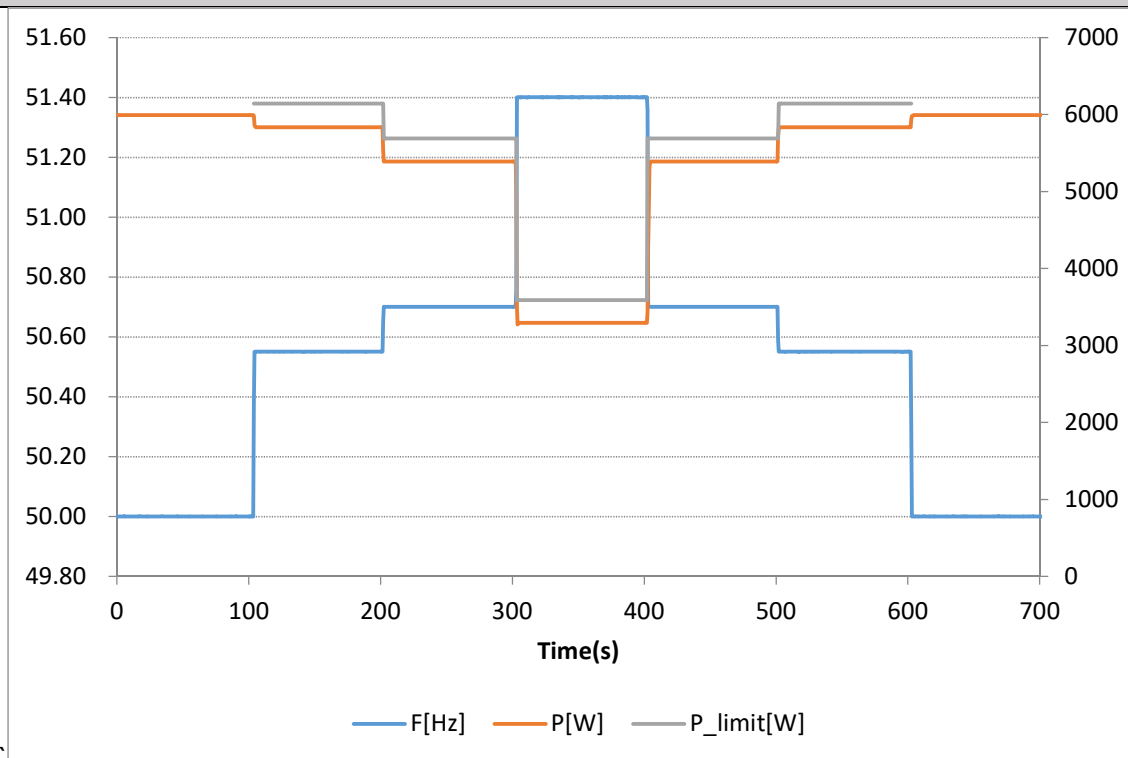

**Graph of Measurement 2 of DK2.:Active power output 40% and 60% after freezing > 80% P<sub>n</sub>**

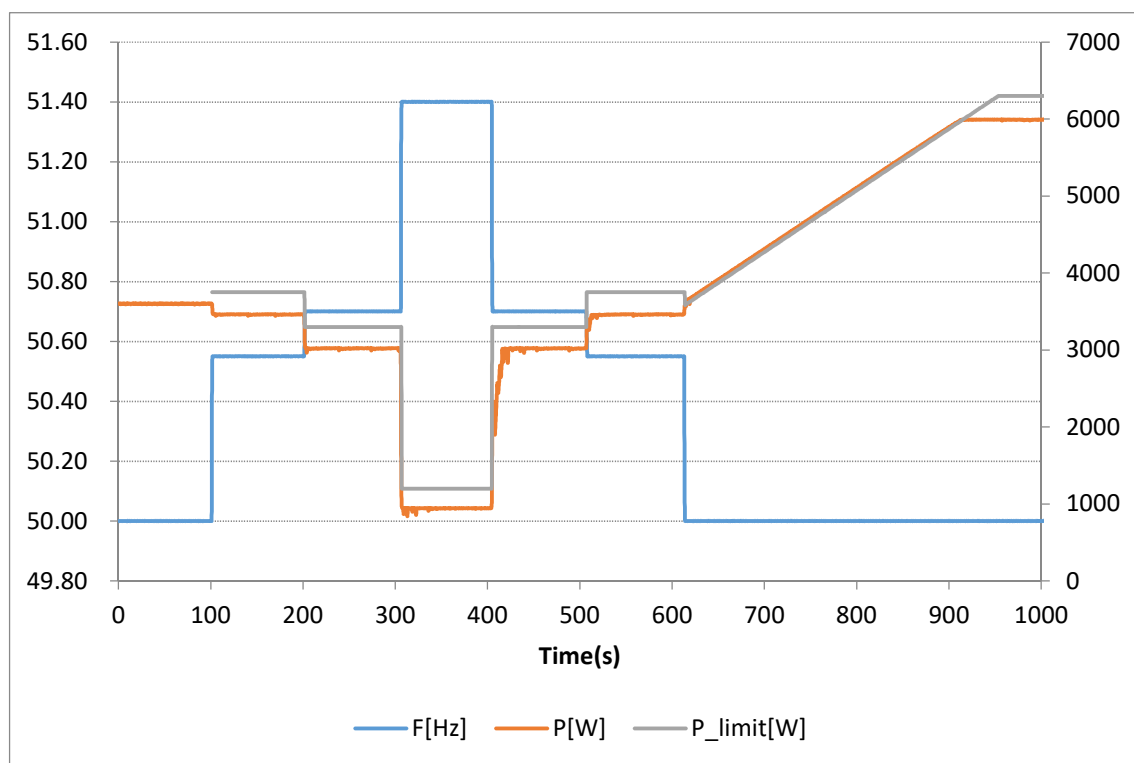

**Test:**

The test is conducted for two powers. First, the test must start at a power =100%  $P_{E_{max}}$  ("Measurement 1"), and in a second test, for a power 60%  $P_{E_{max}}$  ("Measurement 2"). In the second test, after freezing of the  $P_M$ , the available active power output must be increased to a value =100%  $P_{E_{max}}$ , and after the network frequency of 50,2 /50,5Hz is fallen below, the rise of the active power gradient must be recorded.

Point g) must be held until the micro-generator is again feeding in with the active power output available.

**Assessment criterion:**

If frequency increases to above  $f_2$  (LFSSM-O), the droop must be followed, i.e. power flow from the grid increases as frequency increases. If frequency is subsequently stabilised and decreases, the droop must still be followed until system frequency is once again below frequency  $f_2$ .

a) For adjustable micro-generators when:

- 1) the active power reduces between measuring points b) and f) given above with the set gradient  $P_n$  per Hz for a increasing frequency (or rises for a frequency decreasing again).
- 2) the maximum active power gradient occurring in point is less than the configured maximum active power per minute
- 3) the reaction value of the setpoint determined by the gradient characteristic curve does not differ from  $P_{E_{max}}$  by more than  $\pm 10\%$ .
- 4) the settling time is equal or below 2 s with an intentional delay set to zero

b) For partly adjustable micro-generators

- 1) when they behave as in a) within their adjustment range, and
- 2) when, outside the adjustable range, the power fed in on leaving the adjustment range remains constant until shutdown. Shutdown must be no later than at 51,5 Hz.

**Note:**

The tests had been performed on the HYD 6000-EP is valid for the HYD 5500-EP, HYD 5000-EP, HYD 4600-EP , HYD 4000-EP, HYD 3680-EP and HYD 3000-EP, since it is identical in hardware and software construction except output power derated by software.

4.4 Reactive power control				P
4.4.1 Reactive power range				
<b>Test result: HYD 6000-EP</b>				
<b>PF = 0,9 / Inductive reactive power supply</b>				
Rating power [%]	Active power [kW]	Reactive power [kVar]	Power factor [cos φ]	DC power [kW]
10%	0,613	-0,293	0,9024	0,634
20%	1,223	-0,592	0,9002	1,252
30%	1,829	-0,888	0,8995	1,867
40%	2,433	-1,203	0,8964	2,484
50%	3,033	-1,459	0,9011	3,098
60%	3,629	-1,784	0,8974	3,713
70%	4,221	-2,052	0,8994	4,324
80%	4,809	-2,373	0,8967	4,936
90%	5,391	-2,622	0,8993	5,542
100%	5,419	-2,636	0,8993	5,575
<b>PF = 0,9 / Capacitive reactive power supply</b>				
Rating power [%]	Active power [kW]	Reactive power [kVar]	Power factor [cos φ]	DC power [kW]
10%	0,615	0,286	0,9065	0,634
20%	1,226	0,591	0,9007	1,252
30%	1,833	0,879	0,9017	1,868
40%	2,437	1,199	0,8973	2,484
50%	3,037	1,463	0,9009	3,098
60%	3,635	1,727	0,9032	3,713
70%	4,226	2,037	0,9008	4,324
80%	4,814	2,359	0,8980	4,935
90%	5,395	2,662	0,8968	5,541
100%	5,423	2,672	0,8971	5,574



**Cos phi=1 no reactive power supply**

Rating power [%]	Active power [kW]	Reactive power [kVar]	Power factor [cos φ]	DC power [kW]
10%	0,611	0,116	0,9824	0,630
20%	1,224	0,094	0,9970	1,248
30%	1,833	0,073	0,9992	1,865
40%	2,437	0,053	0,9997	2,479
50%	3,039	0,033	0,9999	3,094
60%	3,641	-0,053	0,9999	3,710
70%	4,236	-0,077	0,9998	4,323
80%	4,829	-0,105	0,9998	4,935
90%	5,418	-0,135	0,9997	5,545
100%	6,002	-0,165	0,9996	6,154

**Assessment criterion:**

For the control function, the accuracy of a completed or continuous control operation, including accuracy at the set point, must not deviate by more than 1% of the power factor set point over a period of 0,01 minute. The energy storage facility must be able to set a power factor set point with a resolution of 0,01.

The tests had been performed on the HYD 6000-EP is valid for the HYD 5500-EP, HYD 5000-EP, HYD 4600-EP, HYD 4000-EP, HYD 3680-EP and HYD 3000-EP, since it is identical in hardware and software construction except output power derated by software.

**Diagram**

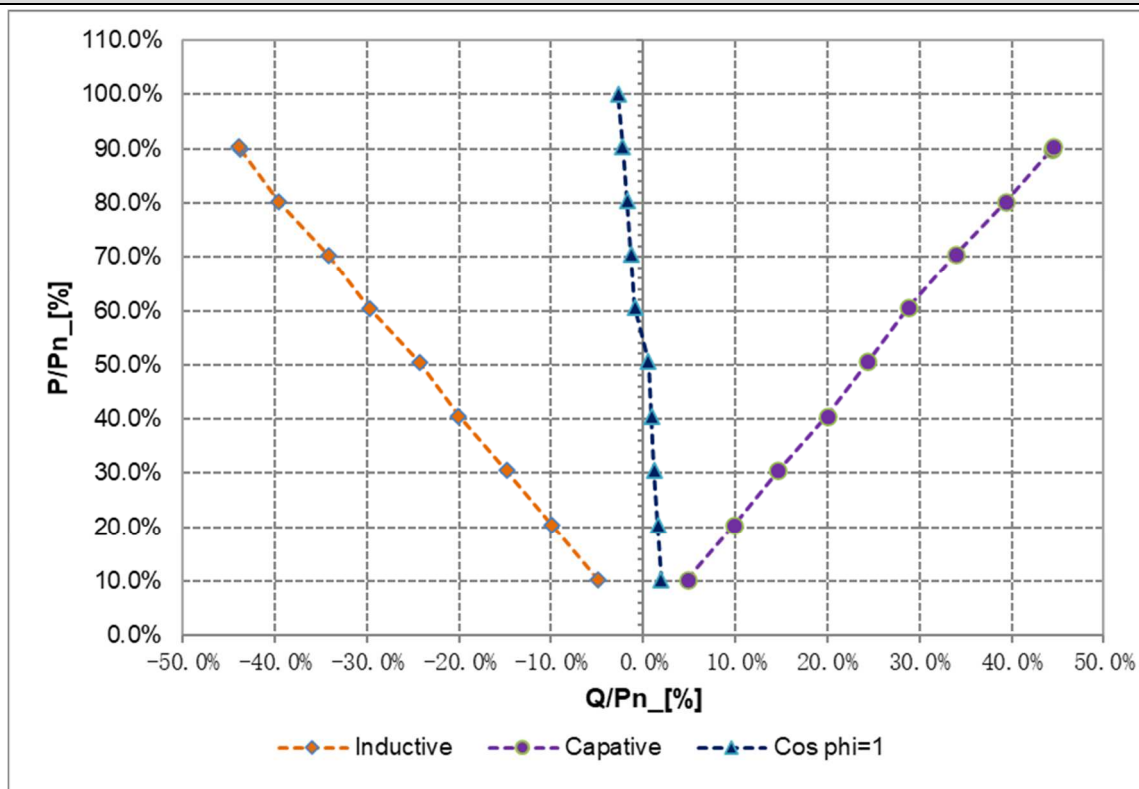

<b>4.4 Reactive power control</b>			<b>P</b>
<b>4.4.2 Power factor control</b>			
<b>Test result: HYD 6000-EP</b>			
		<b>Time</b>	<b>Result</b>
1.	Reaction time PF=1 to PF=-0.90 (100%Pn test)	2,5s	P
2.	Reaction time PF=-0.90 to PF=+0.90 (100%Pn test)	2,5s	P
3.	Reaction time PF=+0.90 to PF=1 (100%Pn test)	1,5s	P
4.	Reaction time PF=1 to PF=-0.90 (50%Pn test)	2,5s	P
5.	Reaction time PF=-0.90 to PF=+0.90 (50%Pn test)	2,5s	P
6.	Reaction time PF=+0.90 to PF=1 (50%Pn test)	2,0s	P
<b>Assessment criterion:</b>			
When a new Power Factor set point is set, the control must be completed within one minute.			
<b>Note:</b>			
The tests had been performed on the HYD 6000-EP is valid for the HYD 5500-EP, HYD 5000-EP, HYD 4600-EP, HYD 4000-EP, HYD 3680-EP and HYD 3000-EP, since it is identical in hardware and software construction except output power derated by software.			

**Graph 100%Pn**

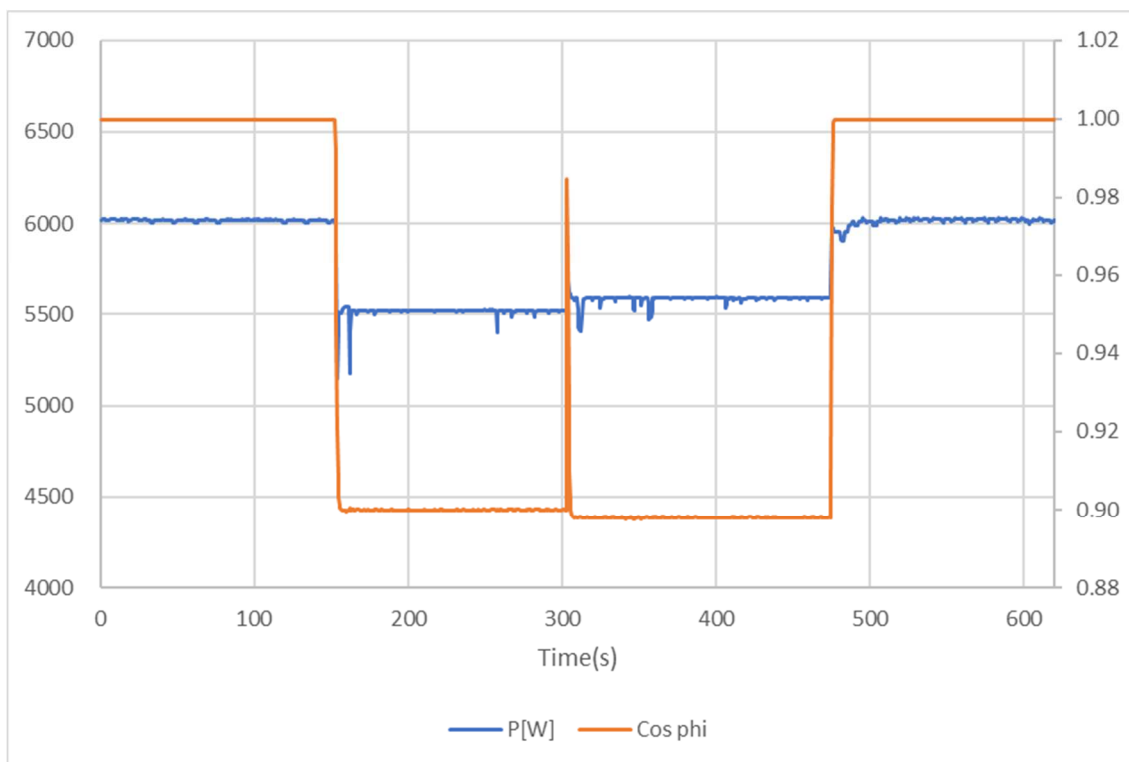

**Graph 50% Pn**

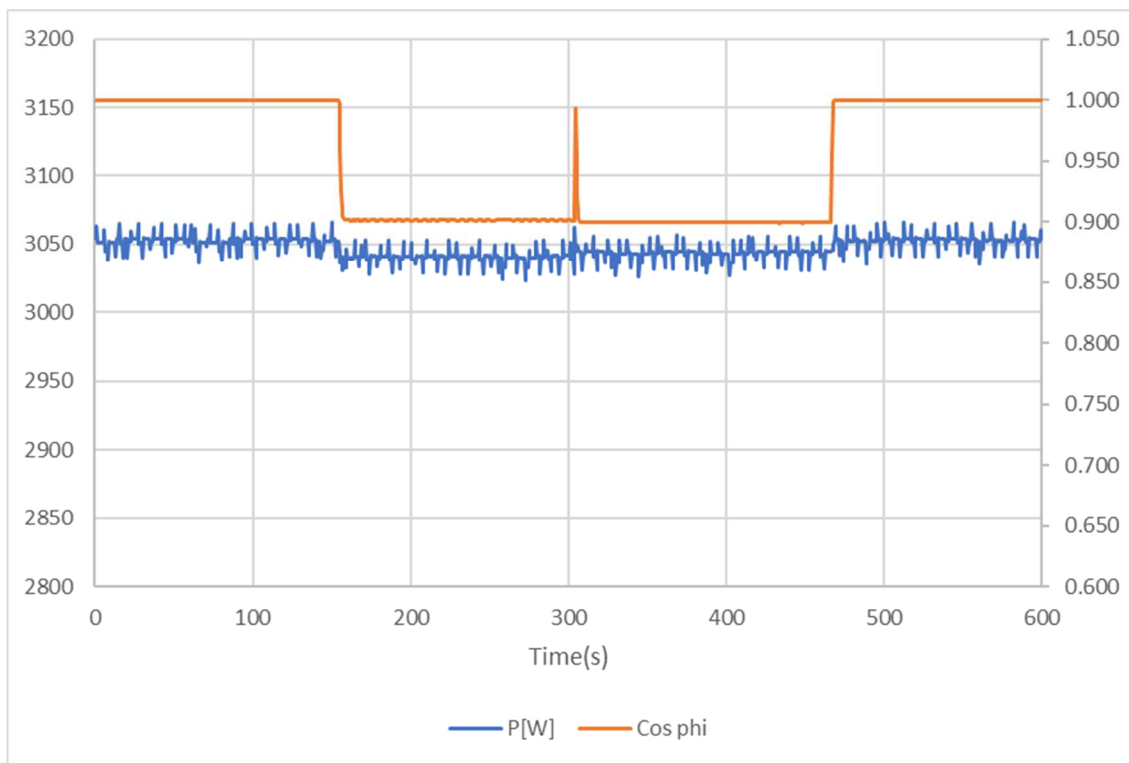

**4.4 Reactive power control**  
**4.4.3 Automatic power factor control**

P

**Test result: HYD 6000-EP**

Inductive reactive power absorption

Power-BIN	Active power P[kW]	Reactive power Q[kVar]	cosφ measured	cosφ expected	Δ cosφ
20%	1,096	0,167	0,9926	1,00	0,007
30%	1,648	0,166	0,9950	1,00	0,005
40%	2,198	0,167	0,9971	1,00	0,003
50%	2,728	0,169	0,9981	1,00	0,002
60%	3,264	-0,547	0,9862	0,98	-0,006
70%	3,801	-1,127	0,9587	0,96	0,001
80%	4,334	-1,595	0,9385	0,94	0,002
90%	4,863	-2,104	0,9178	0,92	0,002
100%	5,320	-2,622	0,8970	0,90	0,003

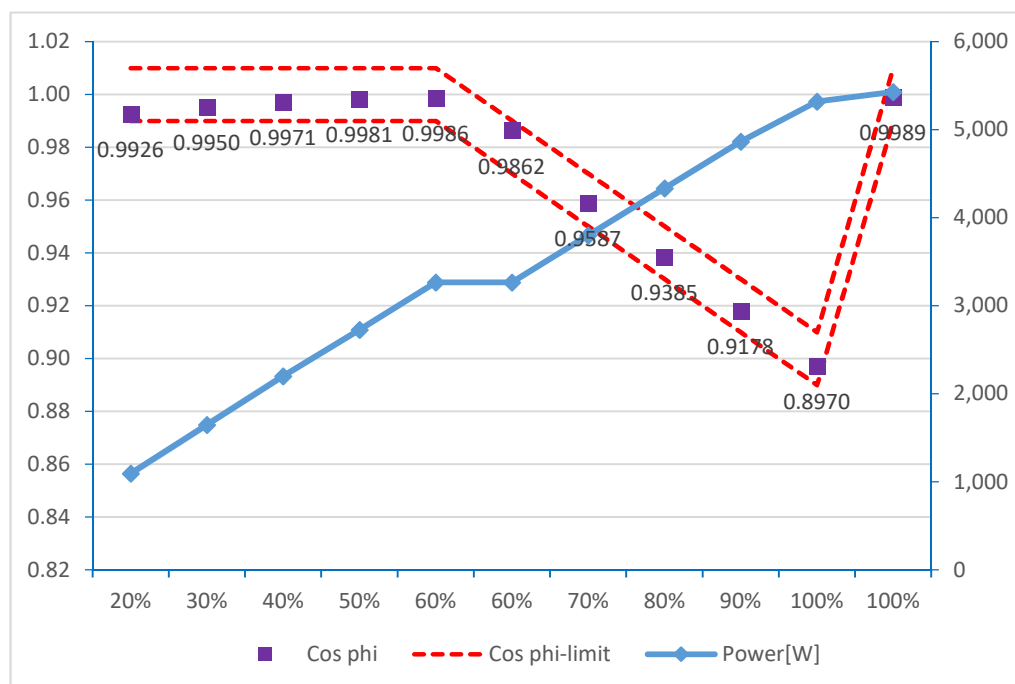

**Note:**

The activation level for the function is normally 105% of rated voltage, and the deactivation level is normally 100% of rated voltage. The activation/deactivation level must be adjustable via set points.

The tests had been performed on the HYD 6000-EP is valid for the HYD 5500-EP, HYD 5000-EP, HYD 4600-EP, HYD 4000-EP, HYD 3680-EP and HYD 3000-EP, since it is identical in hardware and software construction except output power derated by software.

<b>4.4 Reactive power control</b>			<b>P</b>
<b>4.4.4 Q control</b>			
<b>Test result: HYD 6000-EP</b>			
		<b>Time</b>	<b>Result</b>
1.	Reaction time Q=0 to Qmin (100% test)	<1s	P
2.	Reaction time Qmin to Qmax (100% test)	<1s	P
3.	Reaction time Qmax to Q=0 (100% test)	<1s	P
4.	Reaction time Q=0 to Qmin (50% test)	<1s	P
5.	Reaction time Qmin to Qmax (50% test)	<1s	P
6.	Reaction time Qmax to Q=0 (50% test)	<1s	P
<b>Assessment criterion:</b>			
Control from one set point to another must be completed within one minute.			
<b>Note:</b>			
The tests had been performed on the HYD 6000-EP is valid for the HYD 5500-EP, HYD 5000-EP, HYD 4600-EP, HYD 4000-EP, HYD 3680-EP and HYD 3000-EP, since it is identical in hardware and software construction except output power derated by software.			

**Graph 100%Pn**

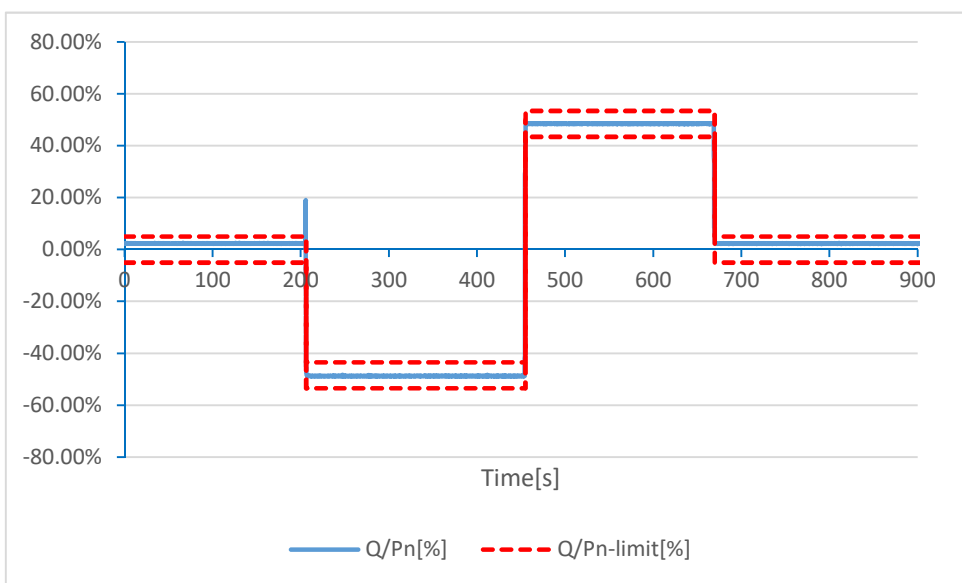

**Graph 50% Pn**

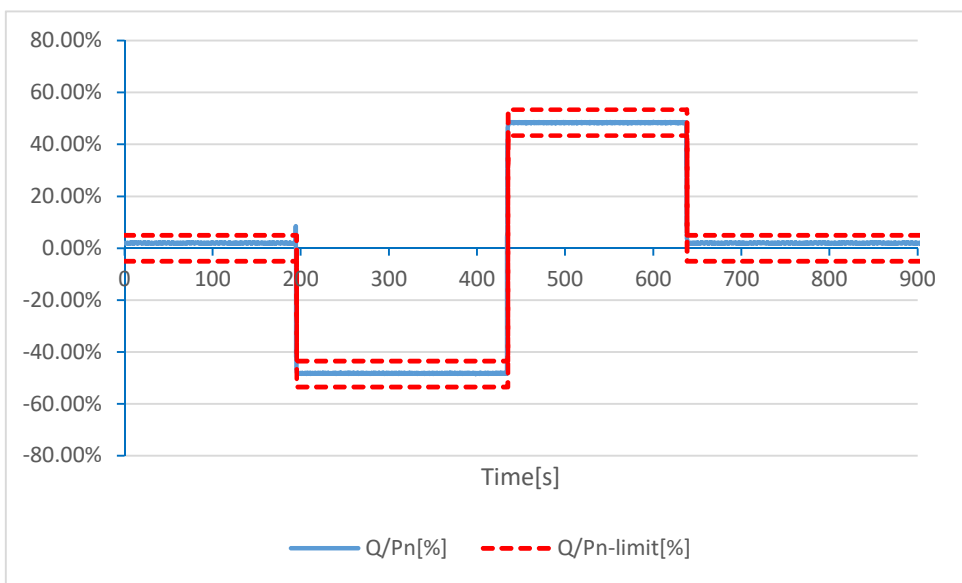

4.5 Protective function						P
<b>Several points to check</b>						
<b>Voltage values</b>						
Threshold	Under voltage Stage 1			Under voltage Stage 2 *		
	Operate voltage	Operate time	Operate voltage	Operate time	Operate voltage	Operate time
Range	0,2-1,0 U <sub>n</sub>	0,1-100s	0,2-1,0 U <sub>n</sub>	0,1-5s		
Default	0,85 U <sub>n</sub>	50s	0,80 U <sub>n</sub>	0,2s		
Steps	0,01 U <sub>n</sub>	0,1 s	0,01 U <sub>n</sub>	0,05s		
Threshold	Over voltage Stage 1		Over voltage Stage 2		Overvoltage 10 min mean protection	
	Operate voltage	Operate time	Operate voltage	Operate time	Operate voltage	Operate time
Range	1,0-1,2 U <sub>n</sub>	0,1-100s	1,0-1,3 U <sub>n</sub>	0,1-5s	1,0-1,15 U <sub>n</sub>	3s not adjustable
Default	1,10 U <sub>n</sub>	60s	1,15 U <sub>n</sub>	0,2s	1,10 U <sub>n</sub>	3s
Steps	0,01 U <sub>n</sub>	0,1s	0,01 U <sub>n</sub>	0,05s	0,01 U <sub>n</sub>	--
<b>Frequency values</b>						
Threshold	Under frequency Stage 1			Under frequency Stage 2		
	Operate frequency	Operate time	Operate frequency	Operate time	Operate frequency	Operate time
Range	47,0-50,0Hz	0,1-5s	--	--	--	--
Default	47,50Hz	0,2s	--	--	--	--
Steps	0,1 Hz	0,1 s	--	--	--	--
Threshold	Overfrequency Stage 1			Overfrequency Stage 2		
	Operate frequency	Operate time	Operate frequency	Operate time	Operate frequency	Operate time
Range	50,0-52,0Hz	0,1-5s	--	--	--	--
Default	51,50Hz	0,2s	--	--	--	--
Steps	0,1 Hz	0,1 s	--	--	--	--
<b>Note:</b>						
*The requirements for islanding detection.						
The tests had been performed on the HYD 6000-EP is valid for the HYD 5500-EP, HYD 5000-EP, HYD 4600-EP, HYD 4000-EP, HYD 3680-EP and HYD 3000-EP, since it is identical in hardware and software construction except output power derated by software.						

4.5 Protective functions (Overvoltage and undervoltage)					P
Test conditions			Frequency: 50+/-0,2Hz		
Phase	Limit [V]	Trip value [V]	Voltage step [V]	Disconnection time [s]	Limit [s]
L1-N	110% of $U_n$ = 253,0  (stage 1)	253,5	230,0 to 258,0	60,1	$60s \leq t \leq 60,1s$
		253,5	230,0 to 258,0	60,0	
		253,5	230,0 to 258,0	60,0	
		253,5	230,0 to 258,0	60,1	
		253,5	230,0 to 258,0	60,0	
	115% of $U_n$ = 264,5  (stage 2)	264,5	230,0 to 268,0	0,208	$0,2s \leq t \leq 0,3s$
		264,5	230,0 to 268,0	0,222	
		264,5	230,0 to 268,0	0,220	
		264,5	230,0 to 268,0	0,220	
		264,5	230,0 to 268,0	0,220	
	85% of $U_n$ = 195,5  (stage 1)	195,6	230,0 to 192,0	50,0	$50s \leq t \leq 50,1s$
		195,6	230,0 to 192,0	50,0	
		195,6	230,0 to 192,0	50,1	
		195,6	230,0 to 192,0	50,0	
		195,6	230,0 to 192,0	50,1	
	80% of $U_n$ = 184  (stage 2)	184,6	230,0 to 180,0	0,217	$0,2s \leq t \leq 0,3s$
		184,6	230,0 to 180,0	0,223	
		184,6	230,0 to 180,0	0,224	
		184,6	230,0 to 180,0	0,213	
		184,6	230,0 to 180,0	0,220	

**Note:**

The permitted tolerance between setting value and trip value of the voltage may not exceed  $\pm 1\%$  of  $U_n$ .

The disconnection time includes disconnect time + operate time of the integrated relay , Therefore limit is give with +100ms according to Table 23 recommended values.

The tests had been performed on the HYD 6000-EP is valid for the HYD 5500-EP, HYD 5000-EP, HYD 4600-EP , HYD 4000-EP, HYD 3680-EP and HYD 3000-EP, since it is identical in hardware and software construction except output power derated by software.



### Scope pictures of the disconnection time

#### Over-voltage - Stage 1 (L1 phase)

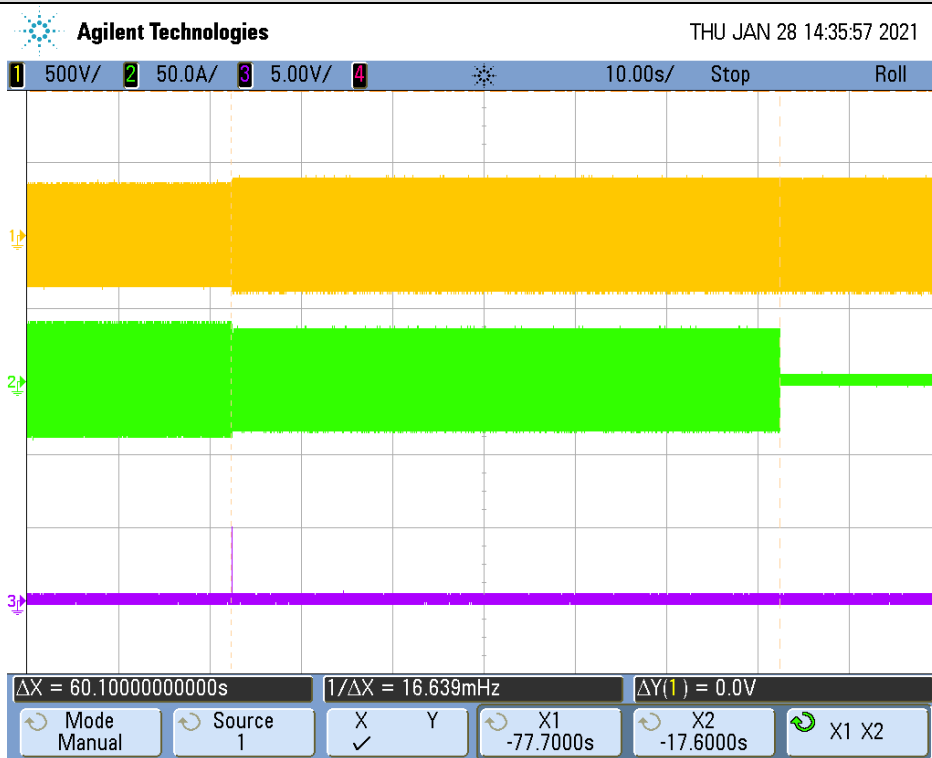

#### Over-voltage - Stage 2 (L1 phase)

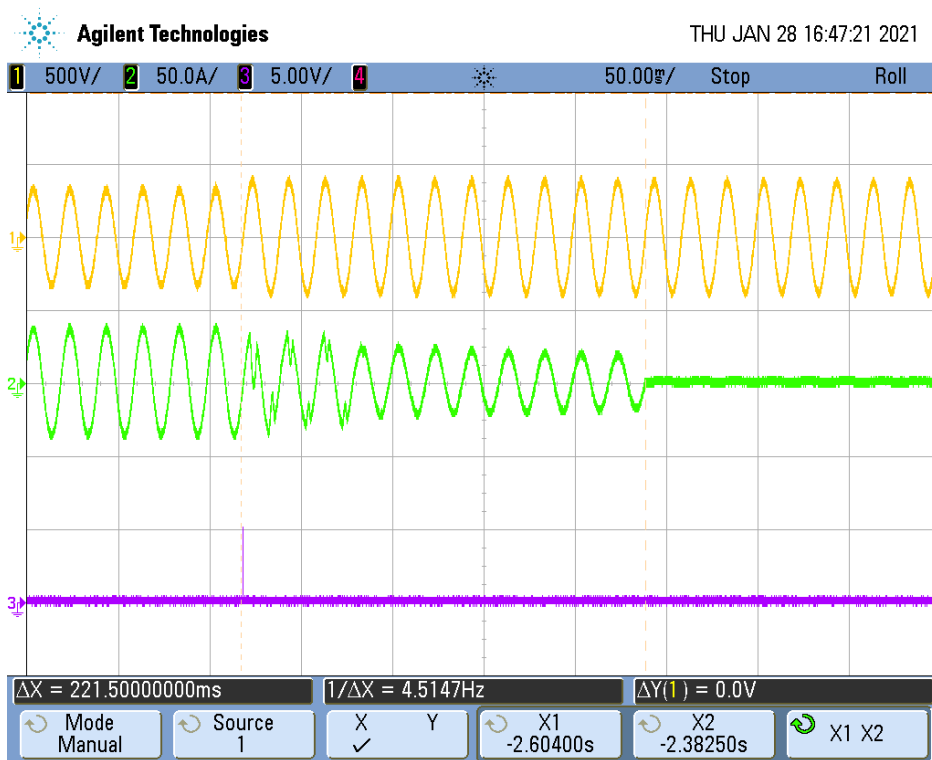

Under-voltage - Stage 1 (L1 phase)

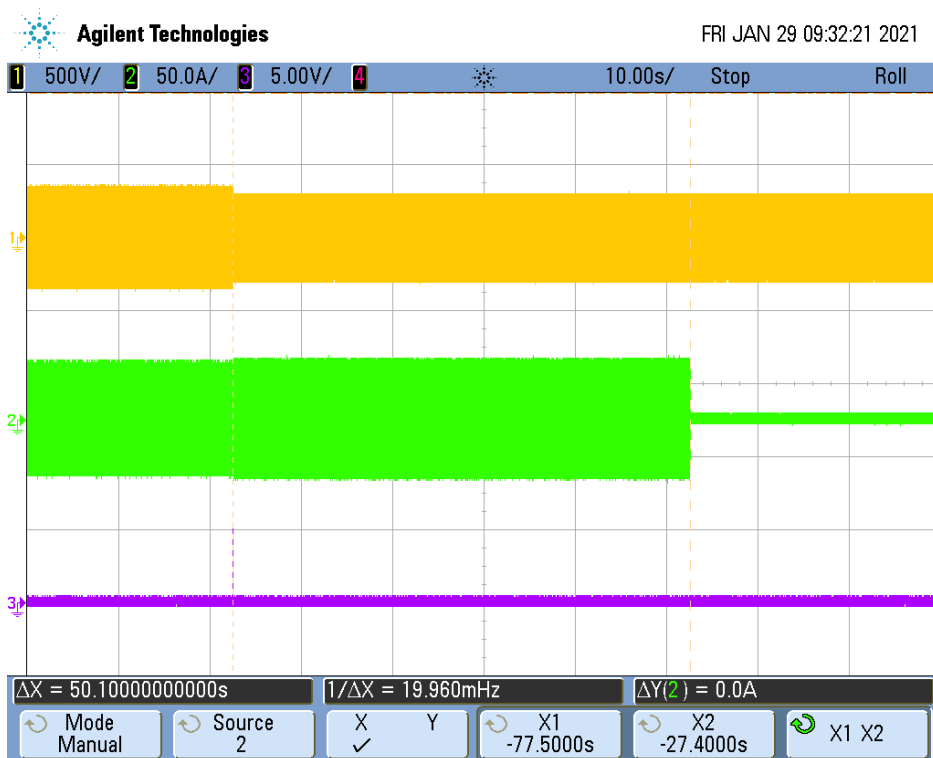

Under-voltage - Stage 2 (L1 phase)



4.5 Protective functions (Overfrequency and underfrequency)				P
Test conditions	U <sub>n</sub> = 230Vac			
	Under-frequency		Over-frequency	
Parameter	Under-Frequency	Time	Over-Frequency	Time
Limit	47,50 Hz	0,2 ≤ t ≤ 0,3 s	51,50 Hz	0,2 ≤ t ≤ 0,3 s
Trip value [Hz]	47,50		51,50	
	47,50		51,50	
	47,50		51,50	
	47,50		51,50	
	47,50		51,50	
Disconnection time [s]	50,00 Hz to 47,40 Hz	0,285	50,00 Hz to 51,60 Hz	0,277
		0,283		0,288
		0,288		0,282
		0,289		0,289
		0,283		0,281

**Note:**

The setting value and the trip value of the frequency may not vary by more than  $\pm 0,1 \% f_n$  ,

The disconnection time includes disconnect time + operate time of the integrated relay , Therefore limit is give with +100ms according to Table 23 and 24 recommended values.

The oscilloscope pictures below show the measured worst case disconnection times.

The tests had been performed on the HYD 6000-EP is valid for the HYD 5500-EP, HYD 5000-EP, HYD 4600-EP , HYD 4000-EP, HYD 3680-EP and HYD 3000-EP, since it is identical in hardware and software construction except output power derated by software.

### Scope pictures of the disconnection time

#### Under-frequency

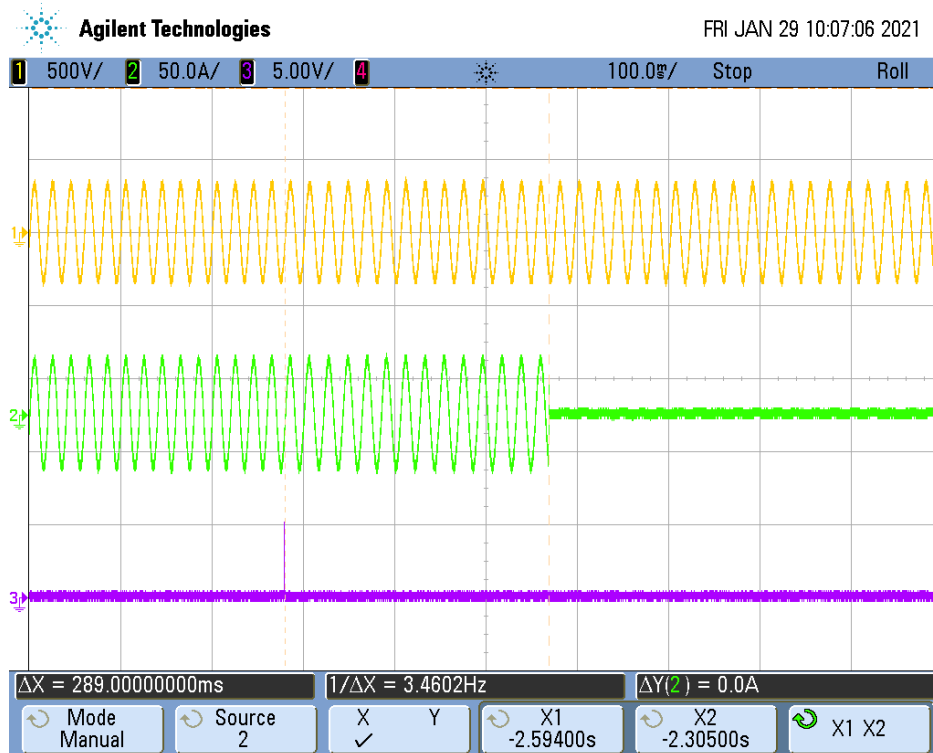

#### Over-frequency

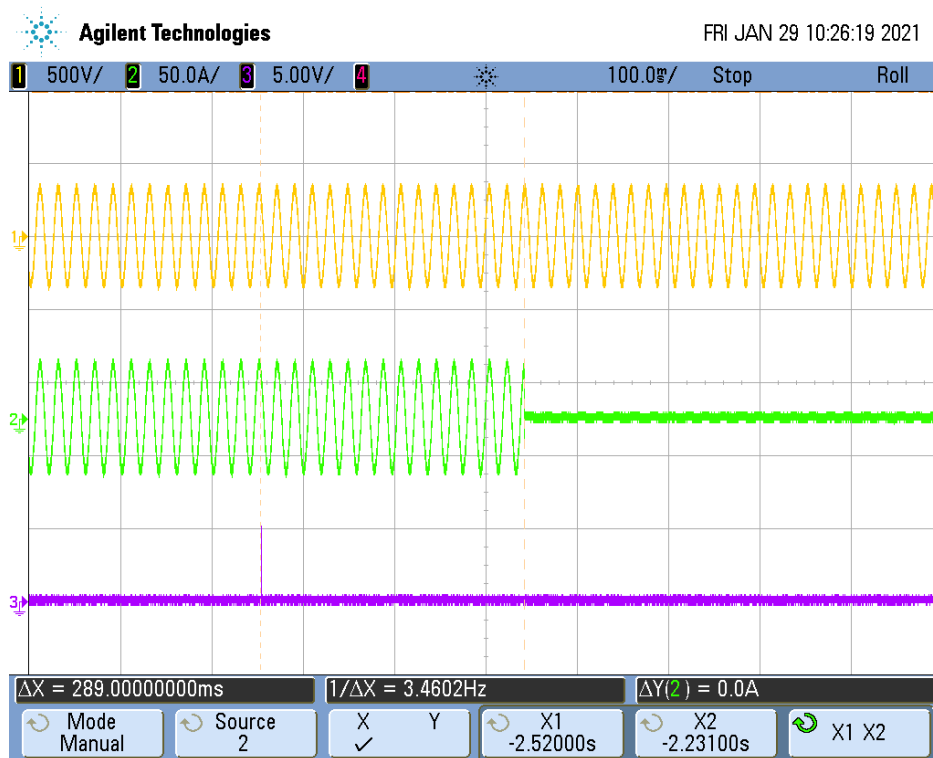

4.6 Power quality				<b>P</b>
4.6.1 Emission limits				
4.6.1.1 DC content				
<b>Test result: HYD 3000-EP</b>				
<b>Protection limit</b>	<b>Tested at four power levels limit 0,5% of <math>I_{AC;nom}</math> (65mA)</b>			
<b>Output power</b>	~20%	~50%	75%	~100%
<b>Max. test value [mA]</b>	25,1	24,0	23,5	15,3
<b>Ave. test value [mA]</b>	14,0	12,8	10,7	0,6
<b>Test result: HYD 6000-EP</b>				
<b>Protection limit</b>	<b>Tested at four power levels limit 0,5% of <math>I_{AC;nom}</math> (145mA)</b>			
<b>Output power</b>	~20%	~50%	75%	~100%
<b>Max. test value [mA]</b>	23,8	22,5	23,5	36,8
<b>Ave. test value [mA]</b>	12,6	11,0	9,6	5,1
<b>Note:</b>				
Test method and setting value refer Annex D.3.10 of EN 50438:2013.				
The tests had been performed on the HYD 6000-EP and HYD 3000-EP is valid for the HYD 5500-EP, HYD 5000-EP, HYD 4600-EP, HYD 4000-EP and HYD 3680-EP, since it is identical in hardware and software construction except output power derated by software.				

**Diagram of permanent dc-injection of HYD 3000-EP**

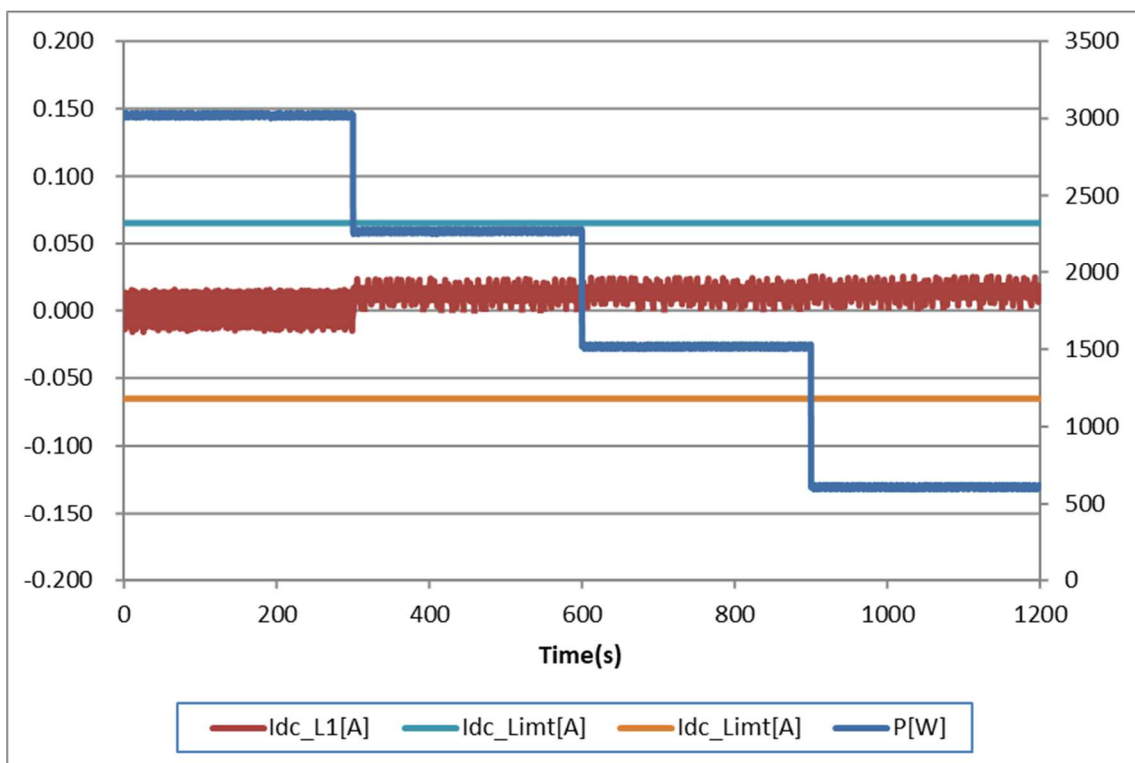

**Diagram of permanent dc-injection of HYD 6000-EP**

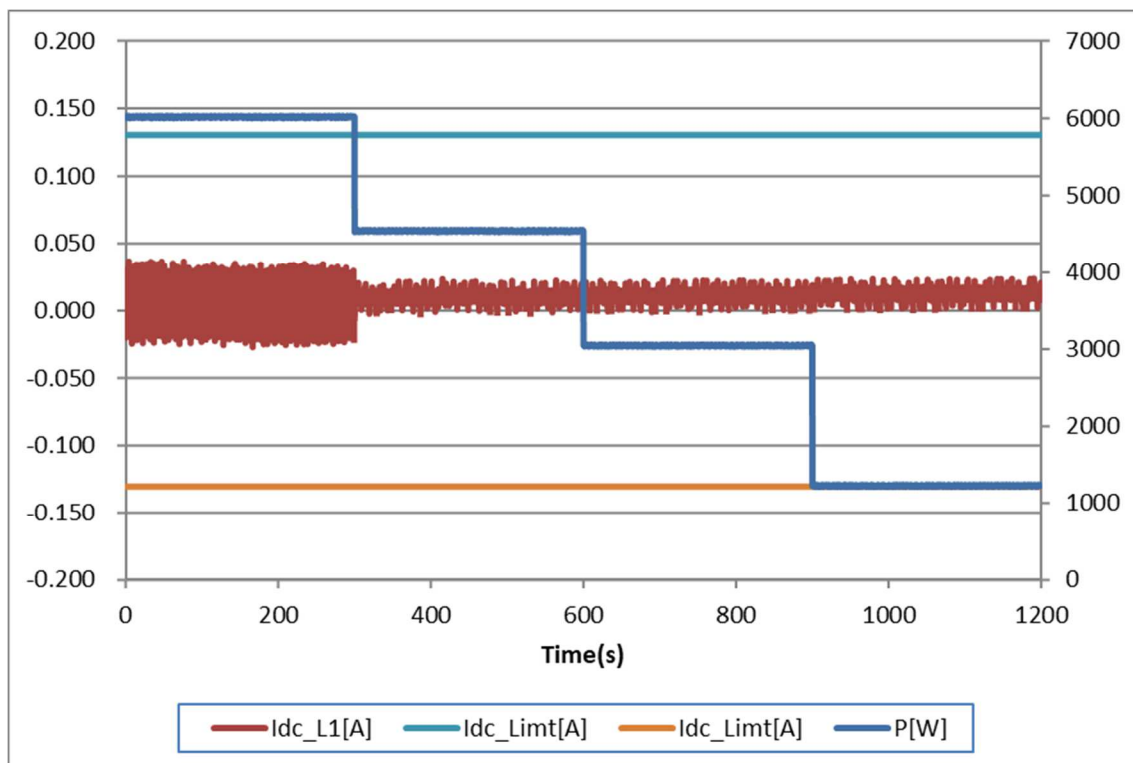

4.6 Power quality						N/A
4.6.1 Emission limits						
4.6.1.2 Current unbalance						
Setting values	PF cos $\phi$ = 1					
Test value	L1	L2	L3	L1 – L2	L2 – L3	L3 – L1
100% of rated current [A]	--	--	--	--	--	--
	--	--	--	--	--	--
	--	--	--	--	--	--
	--	--	--	--	--	--
	--	--	--	--	--	--

Note:  
Energy storage facilities above 11 kW must be balanced three-phase, which means that they must be designed to deliver the same current on all three phases at the same time.

The tests had been performed on the HYD 6000-EP is valid for the HYD 5500-EP, HYD 5000-EP, HYD 4600-EP , HYD 4000-EP, HYD 3680-EP and HYD 3000-EP, since it is identical in hardware and software construction except output power derated by software.

4.6 Power quality					
4.6.1 Emission limits					
4.6.1.3 Rapid voltage changes		P			
<b>Test result: HYD 6000-EP</b>					
Max. number of switching operations, N <sub>10</sub>	10				
Max. number of switching operations, N <sub>120</sub>	120				
Case of switching operation		Cut-in at 9%P <sub>E<sub>max</sub></sub>			
Grid impedance angle, $\psi_k$	30°	50°	70°	85°	
Flicker step factor, $k_f(\psi_k)$	0,056	0,036	0,030	0,028	
Voltage change factor, $k_u(\psi_k)$	0,334	0,338	0,349	0,347	
Maximum inrush current factor $k_{imax}$	0,014				
Case of switching operation		Cut-in at 100%P <sub>E<sub>max</sub></sub>			
Grid impedance angle, $\psi_k$	30°	50°	70°	85°	
Flicker step factor, $k_f(\psi_k)$	0,230	0,151	0,125	0,119	
Voltage change factor, $k_u(\psi_k)$	2,965	2,984	2,928	2,858	
Maximum inrush current factor $k_{imax}$	0,014				
Case of switching operation		Service disconnection at rated power			
Grid impedance angle, $\psi_k$	30°	50°	70°	85°	
Flicker step factor, $k_f(\psi_k)$	0,093	0,061	0,051	0,045	
Voltage change factor, $k_u(\psi_k)$	2,424	2,507	2,592	2,441	
Maximum inrush current factor $k_{imax}$	0,079				
Worst case over all switching operations, $k_{imax}$	0,079				
<b>Note:</b>					
S <sub>k, fic</sub> /S <sub>n</sub> in the fictitious grid was set to:20.					
<b>The test refer IEC 61400-21.</b>					
The tests had been performed on the HYD 6000-EP is valid for the HYD 5500-EP, HYD 5000-EP, HYD 4600-EP, HYD 4000-EP, HYD 3680-EP and HYD 3000-EP, since it is identical in hardware and software construction except output power derated by software.					



4.6 Power quality	<b>P</b>
4.6.1 Emission limits	
4.6.1.3 Flicker	

**Test result: HYD 6000-EP**

<b>Test conditions:</b>	Maximum permissible voltage fluctuation (expressed as a percentage of nominal voltage at 100 % power) and flicker as per EN 61000-3-11.
-------------------------	---

**Test:**

<b>Value</b>	<b>P<sub>st</sub></b>	<b>P<sub>lt</sub> 2 hours</b>	<b>d(t)<sub>500ms</sub></b>	<b>d<sub>c</sub></b>	<b>d<sub>max</sub></b>
<b>Limit</b>	1,0	0,65	3,3%	3,3%	4%
<b>Test value</b>	See below				

**inverter <16A (HYD 3000-EP)**

	dc[%]	dmax[%]	d(t)[ms]	Pst	Plt
Limit	3.30	4.00	500 3.30%	1.00	0.65 N:12
No. 1	0.034 Pass	0.228 Pass	0.0 Pass	0.174 Pass	
2	0.034 Pass	0.219 Pass	0.0 Pass	0.174 Pass	
3	0.037 Pass	0.223 Pass	0.0 Pass	0.173 Pass	
4	0.036 Pass	0.223 Pass	0.0 Pass	0.173 Pass	
5	0.033 Pass	0.226 Pass	0.0 Pass	0.174 Pass	
6	0.036 Pass	0.226 Pass	0.0 Pass	0.174 Pass	
7	0.037 Pass	0.223 Pass	0.0 Pass	0.174 Pass	
8	0.038 Pass	0.221 Pass	0.0 Pass	0.174 Pass	
9	0.035 Pass	0.228 Pass	0.0 Pass	0.176 Pass	
10	0.041 Pass	0.233 Pass	0.0 Pass	0.176 Pass	
11	0.036 Pass	0.241 Pass	0.0 Pass	0.176 Pass	
12	0.037 Pass	0.235 Pass	0.0 Pass	0.176 Pass	
Result	Pass	Pass	Pass	Pass	0.175 Pass

**Inverter >16A (HYD 6000-EP)**

	dc[%]	dmax[%]	d(t)[ms]	Pst	Plt
Limit	3.30	4.00	500 3.30%	1.00	0.65 N:12
No. 1	0.046 Pass	0.217 Pass	0.0 Pass	0.164 Pass	
2	0.044 Pass	0.218 Pass	0.0 Pass	0.164 Pass	
3	0.044 Pass	0.227 Pass	0.0 Pass	0.164 Pass	
4	0.052 Pass	0.229 Pass	0.0 Pass	0.165 Pass	
5	0.051 Pass	0.224 Pass	0.0 Pass	0.166 Pass	
6	0.053 Pass	0.231 Pass	0.0 Pass	0.166 Pass	
7	0.040 Pass	0.226 Pass	0.0 Pass	0.165 Pass	
8	0.036 Pass	0.225 Pass	0.0 Pass	0.166 Pass	
9	0.046 Pass	0.233 Pass	0.0 Pass	0.166 Pass	
10	0.051 Pass	0.225 Pass	0.0 Pass	0.167 Pass	
11	0.047 Pass	0.229 Pass	0.0 Pass	0.168 Pass	
12	0.034 Pass	0.233 Pass	0.0 Pass	0.167 Pass	
Result	Pass	Pass	Pass	Pass	0.166 Pass

**Note:**

\*The stationary deviance of dc% is more relevant than the dynamic deviance of dmax at starting and stopping, Mains Impedance according EN61000-3-11:

**$R_{max} = 0,24\Omega$ ;  $jX_{max} = 0,15\Omega @50Hz$  ( $|Z_{max}| = 0,283/0,4717\Omega$ ) for single phase inverter use also**

**$R_n = 0,16\Omega$ ;  $jX_n = 0,1\Omega$ .**

Calculation of the maximum permissible grid impedance at the point of common coupling based on dc:

**$Z_{max} = Z_{ref} * 3,3\% / d_c(P_n)$ .**

The tests should be based on the limits of the EN 61000-3-3 for less than 16A and on EN 61000-3-11 for more than 16A.

The tests had been performed on the HYD 6000-EP and HYD 3000-EP is valid for the HYD 5500-EP, HYD 5000-EP, HYD 4600-EP, HYD 4000-EP and HYD 3680-EP, since it is identical in hardware and software construction except output power derated by software.

4.6 Power quality				P
4.6.1 Emission limits				
4.6.1.5 Harmonics				
<b>Test result: HYD 3000-EP</b>				
Watts [KW]		3,022		
Vrms [V]		230,41		
Arms [A]		13,13		
Frequency [Hz]		50		
THD50* (100% output power)		1,446		
Harmonic order n	Current Magnitude [A] at 100% rated output power	% of Fundamental	Phase	Harmonic Current Limits [A]
1st	13,126	99,947	Single Phase	--
2nd	0,004	0,029	Single Phase	1,080
3rd	0,162	1,235	Single Phase	2,300
4th	0,002	0,012	Single Phase	0,430
5th	0,077	0,583	Single Phase	1,140
6th	0,002	0,015	Single Phase	0,300
7th	0,039	0,300	Single Phase	0,770
8th	0,001	0,011	Single Phase	0,230
9th	0,021	0,160	Single Phase	0,400
10th	0,001	0,010	Single Phase	0,184
11th	0,010	0,079	Single Phase	0,330
12th	0,001	0,009	Single Phase	0,153
13th	0,007	0,055	Single Phase	0,210
14th	0,001	0,008	Single Phase	0,131
15th	0,006	0,048	Single Phase	0,150
16th	0,001	0,007	Single Phase	0,115
17th	0,009	0,065	Single Phase	0,132
18th	0,001	0,007	Single Phase	0,102
19th	0,009	0,072	Single Phase	0,118
20th	0,001	0,007	Single Phase	0,092
21th	0,011	0,080	Single Phase	0,107
22th	0,001	0,006	Single Phase	0,084
23th	0,011	0,087	Single Phase	0,098
24th	0,001	0,006	Single Phase	0,077
25th	0,011	0,085	Single Phase	0,090
26th	0,001	0,005	Single Phase	0,071
27th	0,011	0,087	Single Phase	0,083
28th	0,001	0,005	Single Phase	0,066
29th	0,011	0,082	Single Phase	0,078
30th	0,001	0,006	Single Phase	0,061
31th	0,011	0,082	Single Phase	0,073
32th	0,001	0,005	Single Phase	0,058
33th	0,011	0,081	Single Phase	0,068
34th	0,001	0,006	Single Phase	0,054
35th	0,010	0,075	Single Phase	0,064
36th	0,001	0,006	Single Phase	0,051
37th	0,010	0,075	Single Phase	0,061
38th	0,001	0,006	Single Phase	0,048
39th	0,010	0,076	Single Phase	0,058
40th	0,001	0,005	Single Phase	0,046
<b>Note:</b> The tests should be based on the limits of the EN 61000-3-2 for less than 16A.				

4.8 EMC and power quality Harmonic current emission (EN 61000-3-2)				P
<b>Test result: HYD 6000-EP</b>				
Watts [KW]		6,034		
Vrms [V]		230,70		
Arms [A]		26,17		
Frequency [Hz]		50		
THD50* (100% output power)		0,965		
Harmonic order n	Current Magnitude [A] at 100% rated output power	% of Fundamental	Phase	Harmonic Current Limits [%]
1st	26,157	99,961	Single Phase	--
2nd	0,007	0,026	Single Phase	8,000
3rd	0,207	0,792	Single Phase	21,600
4th	0,002	0,007	Single Phase	4,000
5th	0,109	0,417	Single Phase	10,700
6th	0,003	0,013	Single Phase	2,667
7th	0,067	0,255	Single Phase	7,200
8th	0,003	0,012	Single Phase	2,000
9th	0,042	0,159	Single Phase	3,800
10th	0,003	0,012	Single Phase	1,600
11th	0,020	0,077	Single Phase	3,100
12th	0,003	0,010	Single Phase	1,333
13th	0,012	0,044	Single Phase	2,000
14th	0,002	0,009	Single Phase	8,000
15th	0,013	0,050	Single Phase	N/A
16th	0,002	0,008	Single Phase	N/A
17th	0,017	0,065	Single Phase	N/A
18th	0,002	0,007	Single Phase	N/A
19th	0,017	0,064	Single Phase	N/A
20th	0,001	0,005	Single Phase	N/A
21th	0,015	0,059	Single Phase	N/A
22th	0,001	0,005	Single Phase	N/A
23th	0,013	0,049	Single Phase	N/A
24th	0,001	0,005	Single Phase	N/A
25th	0,011	0,044	Single Phase	N/A
26th	0,001	0,004	Single Phase	N/A
27th	0,012	0,044	Single Phase	N/A
28th	0,001	0,006	Single Phase	N/A
29th	0,010	0,040	Single Phase	N/A
30th	0,001	0,005	Single Phase	N/A
31th	0,010	0,039	Single Phase	N/A
32th	0,001	0,004	Single Phase	N/A
33th	0,009	0,036	Single Phase	N/A
34th	0,001	0,004	Single Phase	N/A
35th	0,008	0,029	Single Phase	N/A
36th	0,001	0,005	Single Phase	N/A
37th	0,007	0,027	Single Phase	N/A
38th	0,001	0,005	Single Phase	N/A
39th	0,007	0,028	Single Phase	N/A
40th	0,001	0,004	Single Phase	N/A
<b>Note:</b> The tests should be based on the limits of the EN 61000-3-12 for more than 16A.				

4.6 Power quality											P
4.6.1 Emission limits											
4.6.1.6 Interharmonics											
4.6.1.7 Distortions in the 2-9kHz frequency range											
The currents of the interharmonics to 2 kHz must be measured in accordance with DIN EN 61000-4-7 (VDE 0817-4-7), Annex A. The measurements of higher-frequency harmonic currents between 2 kHz and 9 kHz must be conducted in line with DIN EN 61000-4-7 (VDE 0847-4-7), Annex B.											
Harmonic: HYD 3000-EP											
P/P <sub>n</sub> [%]	0	10	20	30	40	50	60	70	80	90	100
Order	I [%In]	I [%In]	I [%In]	I [%In]	I [%In]	I [%In]	I [%In]	I [%In]	I [%In]	I [%In]	I [%In]
1	2,970	10,467	20,579	30,726	40,816	50,853	60,856	70,786	80,677	90,505	100,260
2	0,018	0,025	0,024	0,018	0,019	0,019	0,018	0,016	0,015	0,017	0,044
3	0,476	0,608	0,618	0,625	0,635	0,638	0,640	0,645	0,651	0,692	0,809
4	0,016	0,011	0,011	0,009	0,009	0,010	0,011	0,011	0,013	0,012	0,015
5	0,273	0,303	0,299	0,294	0,292	0,291	0,287	0,277	0,270	0,305	0,399
6	0,012	0,008	0,009	0,007	0,007	0,008	0,008	0,008	0,007	0,013	0,021
7	0,180	0,168	0,155	0,154	0,150	0,148	0,139	0,132	0,128	0,168	0,242
8	0,008	0,008	0,008	0,007	0,007	0,008	0,008	0,008	0,007	0,009	0,010
9	0,110	0,099	0,093	0,090	0,085	0,079	0,074	0,072	0,074	0,114	0,158
10	0,007	0,008	0,008	0,007	0,007	0,007	0,008	0,008	0,007	0,011	0,012
11	0,076	0,066	0,061	0,050	0,044	0,039	0,039	0,049	0,063	0,077	0,076
12	0,007	0,007	0,007	0,006	0,007	0,007	0,007	0,007	0,008	0,010	0,012
13	0,064	0,055	0,044	0,030	0,027	0,029	0,038	0,056	0,074	0,069	0,047
14	0,007	0,006	0,007	0,006	0,006	0,007	0,007	0,007	0,008	0,010	0,010
15	0,052	0,051	0,035	0,027	0,023	0,029	0,047	0,065	0,082	0,070	0,059
16	0,006	0,006	0,006	0,006	0,006	0,006	0,007	0,007	0,007	0,011	0,008
17	0,057	0,053	0,036	0,028	0,026	0,040	0,058	0,074	0,089	0,077	0,076
18	0,006	0,005	0,006	0,005	0,006	0,006	0,006	0,006	0,006	0,011	0,009
19	0,057	0,053	0,034	0,027	0,032	0,046	0,061	0,076	0,087	0,079	0,074
20	0,006	0,005	0,005	0,005	0,005	0,006	0,006	0,006	0,006	0,010	0,008
21	0,062	0,055	0,035	0,029	0,035	0,050	0,066	0,079	0,088	0,081	0,069
22	0,006	0,005	0,005	0,005	0,005	0,005	0,005	0,006	0,006	0,009	0,008
23	0,065	0,055	0,035	0,031	0,039	0,055	0,068	0,078	0,084	0,077	0,058
24	0,006	0,005	0,005	0,004	0,005	0,005	0,006	0,006	0,007	0,009	0,008
25	0,067	0,053	0,033	0,032	0,039	0,055	0,065	0,074	0,079	0,072	0,054
26	0,006	0,004	0,004	0,004	0,004	0,005	0,005	0,006	0,006	0,007	0,007
27	0,066	0,053	0,035	0,035	0,043	0,057	0,067	0,076	0,079	0,069	0,053
28	0,006	0,005	0,004	0,004	0,005	0,005	0,006	0,006	0,006	0,008	0,008
29	0,064	0,048	0,031	0,033	0,041	0,054	0,066	0,072	0,073	0,062	0,049
30	0,006	0,004	0,004	0,004	0,005	0,005	0,005	0,006	0,006	0,007	0,007
31	0,060	0,048	0,032	0,033	0,042	0,056	0,065	0,070	0,070	0,060	0,048
32	0,006	0,005	0,004	0,004	0,005	0,005	0,005	0,005	0,006	0,007	0,007
33	0,059	0,044	0,031	0,033	0,041	0,055	0,064	0,068	0,068	0,058	0,045
34	0,007	0,005	0,004	0,004	0,005	0,005	0,006	0,006	0,006	0,008	0,007
35	0,050	0,040	0,028	0,030	0,040	0,054	0,062	0,065	0,063	0,053	0,037
36	0,007	0,005	0,005	0,005	0,005	0,005	0,006	0,006	0,006	0,008	0,008
37	0,049	0,037	0,026	0,029	0,038	0,052	0,061	0,064	0,062	0,051	0,035
38	0,008	0,005	0,005	0,005	0,005	0,005	0,005	0,006	0,006	0,007	0,007
39	0,047	0,040	0,028	0,030	0,040	0,055	0,062	0,063	0,061	0,050	0,036
40	0,008	0,006	0,006	0,006	0,006	0,006	0,006	0,006	0,006	0,007	0,008

Interharmonics: HYD 3000-EP												
P/Pn [%]	0	10	20	30	40	50	60	70	80	90	100	Limit
f [Hz]	I [%In]	I [%In]	I [%In]	I [%In]	I [%In]	I [%In]	I [%In]	I [%In]	I [%In]	I [%In]	I [%In]	I [%In]
75	0,050	0,066	0,068	0,041	0,041	0,042	0,043	0,044	0,043	0,043	0,058	0,40
125	0,025	0,023	0,022	0,015	0,015	0,017	0,017	0,015	0,015	0,014	0,018	0,60
175	0,024	0,014	0,015	0,012	0,011	0,012	0,013	0,012	0,011	0,011	0,014	0,43
225	0,019	0,013	0,014	0,011	0,011	0,011	0,012	0,011	0,011	0,011	0,012	0,33
275	0,018	0,011	0,013	0,011	0,011	0,011	0,012	0,012	0,011	0,011	0,012	0,27
325	0,017	0,012	0,013	0,011	0,012	0,012	0,012	0,012	0,012	0,012	0,013	0,23
375	0,012	0,012	0,013	0,011	0,012	0,012	0,013	0,012	0,012	0,012	0,013	0,20
425	0,011	0,012	0,013	0,012	0,012	0,012	0,013	0,012	0,012	0,013	0,013	0,18
475	0,010	0,011	0,012	0,011	0,012	0,012	0,013	0,013	0,013	0,013	0,013	0,16
525	0,010	0,011	0,011	0,011	0,011	0,012	0,013	0,013	0,012	0,013	0,013	0,14
575	0,010	0,010	0,011	0,011	0,011	0,012	0,012	0,012	0,013	0,013	0,013	0,13
625	0,010	0,010	0,010	0,010	0,011	0,011	0,012	0,012	0,012	0,013	0,013	0,12
675	0,010	0,009	0,010	0,010	0,010	0,011	0,012	0,012	0,013	0,013	0,013	0,11
725	0,010	0,009	0,009	0,009	0,010	0,011	0,011	0,012	0,012	0,013	0,013	0,10
775	0,010	0,009	0,009	0,009	0,010	0,010	0,011	0,012	0,012	0,013	0,013	0,10
825	0,010	0,008	0,008	0,009	0,009	0,010	0,011	0,011	0,012	0,013	0,013	0,09
875	0,009	0,008	0,008	0,008	0,009	0,010	0,011	0,011	0,012	0,012	0,013	0,09
925	0,009	0,008	0,008	0,008	0,009	0,009	0,010	0,011	0,011	0,012	0,013	0,08
975	0,012	0,010	0,010	0,010	0,011	0,012	0,012	0,013	0,014	0,014	0,015	0,08
1025	0,009	0,007	0,007	0,007	0,008	0,009	0,009	0,010	0,011	0,012	0,012	0,07
1075	0,013	0,010	0,010	0,011	0,011	0,012	0,012	0,013	0,014	0,015	0,017	0,07
1125	0,009	0,007	0,007	0,007	0,008	0,008	0,009	0,010	0,011	0,012	0,013	0,07
1175	0,009	0,007	0,007	0,007	0,007	0,008	0,009	0,010	0,011	0,012	0,013	0,06
1225	0,009	0,007	0,007	0,007	0,007	0,008	0,009	0,010	0,011	0,012	0,013	0,06
1275	0,009	0,007	0,007	0,007	0,007	0,008	0,009	0,010	0,011	0,012	0,013	0,06
1325	0,009	0,007	0,007	0,007	0,007	0,008	0,009	0,009	0,010	0,012	0,013	0,06
1375	0,009	0,007	0,007	0,007	0,007	0,008	0,009	0,009	0,010	0,012	0,013	0,05
1425	0,009	0,007	0,007	0,007	0,007	0,008	0,008	0,009	0,010	0,012	0,013	0,05
1475	0,009	0,007	0,007	0,007	0,007	0,008	0,008	0,009	0,010	0,011	0,013	0,05
1525	0,009	0,007	0,007	0,007	0,007	0,007	0,008	0,009	0,010	0,011	0,012	0,05
1575	0,009	0,007	0,007	0,007	0,007	0,008	0,008	0,009	0,010	0,011	0,013	0,05
1625	0,009	0,007	0,007	0,007	0,007	0,007	0,008	0,009	0,010	0,011	0,012	0,05
1675	0,010	0,008	0,007	0,007	0,008	0,008	0,009	0,009	0,010	0,011	0,013	0,04
1725	0,009	0,007	0,007	0,007	0,007	0,007	0,008	0,009	0,010	0,011	0,012	0,04
1775	0,011	0,008	0,008	0,008	0,008	0,008	0,009	0,009	0,010	0,011	0,012	0,04
1825	0,010	0,007	0,007	0,007	0,007	0,008	0,008	0,009	0,010	0,010	0,012	0,04
1875	0,010	0,008	0,007	0,007	0,007	0,008	0,008	0,009	0,010	0,011	0,011	0,04
1925	0,010	0,008	0,007	0,007	0,007	0,008	0,008	0,009	0,010	0,010	0,011	0,04
1975	0,011	0,008	0,008	0,007	0,007	0,008	0,008	0,009	0,010	0,011	0,012	0,04

Higher Frequencies: HYD 3000-EP												
P/P <sub>n</sub> [%]	0	10	20	30	40	50	60	70	80	90	100	Limit
f [kHz]	I [%In]	I [%In]	I [%In]	I [%In]	I [%In]	I [%In]	I [%In]	I [%In]	I [%In]	I [%In]	I [%In]	I [%In]
2,1	0,064	0,052	0,037	0,040	0,055	0,073	0,084	0,085	0,079	0,064	0,046	0,2
2,3	0,062	0,049	0,035	0,038	0,054	0,074	0,084	0,084	0,078	0,061	0,042	0,2
2,5	0,072	0,061	0,049	0,049	0,062	0,078	0,085	0,083	0,079	0,064	0,051	0,2
2,7	0,065	0,052	0,038	0,041	0,057	0,074	0,080	0,078	0,071	0,056	0,037	0,2
2,9	0,060	0,050	0,036	0,038	0,054	0,070	0,076	0,071	0,063	0,048	0,034	0,2
3,1	0,058	0,048	0,038	0,040	0,056	0,069	0,073	0,069	0,062	0,048	0,034	0,2
3,3	0,051	0,044	0,034	0,036	0,048	0,060	0,064	0,060	0,053	0,041	0,030	0,2
3,5	0,046	0,041	0,033	0,035	0,045	0,053	0,055	0,051	0,044	0,035	0,027	0,2
3,7	0,043	0,039	0,033	0,035	0,044	0,050	0,052	0,049	0,043	0,034	0,028	0,2
3,9	0,037	0,033	0,029	0,032	0,038	0,043	0,044	0,042	0,037	0,031	0,026	0,2
4,1	0,031	0,027	0,024	0,026	0,032	0,036	0,038	0,036	0,032	0,027	0,023	0,2
4,3	0,027	0,023	0,021	0,023	0,026	0,029	0,031	0,030	0,027	0,023	0,021	0,2
4,5	0,023	0,021	0,019	0,020	0,022	0,025	0,026	0,025	0,023	0,022	0,021	0,2
4,7	0,036	0,035	0,033	0,033	0,033	0,034	0,035	0,035	0,034	0,033	0,033	0,2
4,9	0,035	0,033	0,032	0,032	0,032	0,033	0,033	0,033	0,033	0,032	0,032	0,2
5,1	0,016	0,015	0,014	0,015	0,016	0,018	0,019	0,018	0,017	0,016	0,016	0,2
5,3	0,015	0,014	0,013	0,014	0,015	0,016	0,016	0,016	0,015	0,015	0,014	0,2
5,5	0,014	0,013	0,013	0,013	0,014	0,014	0,015	0,014	0,014	0,014	0,014	0,2
5,7	0,019	0,019	0,018	0,018	0,018	0,018	0,018	0,018	0,018	0,018	0,019	0,2
5,9	0,018	0,018	0,017	0,017	0,016	0,016	0,017	0,017	0,017	0,017	0,018	0,2
6,1	0,011	0,010	0,010	0,010	0,010	0,010	0,011	0,011	0,011	0,012	0,012	0,2
6,3	0,010	0,010	0,010	0,009	0,009	0,009	0,010	0,011	0,011	0,011	0,011	0,2
6,5	0,010	0,010	0,010	0,009	0,009	0,009	0,010	0,011	0,011	0,011	0,011	0,2
6,7	0,010	0,010	0,009	0,009	0,009	0,009	0,010	0,010	0,011	0,011	0,011	0,2
6,9	0,011	0,011	0,010	0,010	0,010	0,010	0,010	0,011	0,011	0,011	0,012	0,2
7,1	0,010	0,010	0,009	0,009	0,008	0,008	0,009	0,010	0,010	0,010	0,010	0,2
7,3	0,010	0,009	0,009	0,009	0,008	0,008	0,009	0,010	0,010	0,010	0,010	0,2
7,5	0,010	0,010	0,009	0,009	0,008	0,008	0,009	0,010	0,010	0,010	0,010	0,2
7,7	0,009	0,009	0,009	0,008	0,008	0,008	0,009	0,009	0,010	0,010	0,010	0,2
7,9	0,009	0,009	0,009	0,008	0,008	0,008	0,008	0,009	0,009	0,009	0,010	0,2
8,1	0,009	0,008	0,008	0,007	0,007	0,007	0,008	0,008	0,009	0,009	0,009	0,2
8,3	0,008	0,008	0,008	0,007	0,007	0,007	0,008	0,008	0,009	0,009	0,009	0,2
8,5	0,008	0,008	0,008	0,007	0,007	0,007	0,008	0,008	0,009	0,009	0,009	0,2
8,7	0,008	0,008	0,007	0,007	0,007	0,007	0,008	0,008	0,008	0,008	0,008	0,2
8,9	0,007	0,007	0,007	0,006	0,006	0,007	0,007	0,007	0,008	0,008	0,008	0,2

**Note:**

The normalization current is 15,0A for HYD 3000-EP .

The tests had been performed on the HYD 6000-EP and HYD 3000-EPs valid for the HYD 5500-EP, HYD 5000-EP, HYD 4600-EP , HYD 4000-EP and HYD 3680-EP, since it is identical in hardware and software construction except output power derated by software.



Harmonic (HYD 6000-EP)											
P/P <sub>n</sub> [%]	0	10	20	30	40	50	60	70	80	90	100
Order	I [%In]	I [%In]	I [%In]	I [%In]	I [%In]	I [%In]	I [%In]	I [%In]	I [%In]	I [%In]	I [%In]
1	2,965	10,447	20,528	30,625	40,691	50,691	60,672	70,560	80,425	90,206	99,926
2	0,017	0,017	0,018	0,017	0,017	0,017	0,020	0,017	0,019	0,016	0,045
3	0,477	0,613	0,619	0,624	0,633	0,638	0,639	0,644	0,650	0,690	0,804
4	0,016	0,008	0,008	0,008	0,008	0,009	0,011	0,009	0,010	0,015	0,013
5	0,275	0,302	0,297	0,293	0,291	0,291	0,287	0,278	0,269	0,302	0,394
6	0,011	0,007	0,007	0,007	0,007	0,007	0,008	0,008	0,007	0,013	0,021
7	0,180	0,168	0,155	0,154	0,151	0,149	0,141	0,134	0,128	0,165	0,237
8	0,008	0,007	0,007	0,007	0,007	0,007	0,007	0,007	0,008	0,009	0,011
9	0,111	0,099	0,092	0,090	0,086	0,080	0,075	0,072	0,074	0,111	0,154
10	0,008	0,007	0,007	0,007	0,007	0,007	0,008	0,008	0,007	0,009	0,012
11	0,076	0,066	0,062	0,050	0,044	0,040	0,040	0,049	0,062	0,076	0,076
12	0,007	0,007	0,006	0,007	0,007	0,007	0,007	0,007	0,007	0,010	0,012
13	0,064	0,055	0,044	0,030	0,028	0,029	0,038	0,054	0,073	0,069	0,047
14	0,007	0,006	0,006	0,006	0,006	0,006	0,007	0,007	0,007	0,010	0,010
15	0,052	0,052	0,035	0,027	0,023	0,029	0,047	0,064	0,081	0,070	0,059
16	0,006	0,005	0,005	0,006	0,006	0,006	0,007	0,007	0,007	0,010	0,008
17	0,057	0,054	0,036	0,028	0,026	0,039	0,057	0,073	0,088	0,077	0,075
18	0,006	0,005	0,005	0,006	0,006	0,006	0,006	0,006	0,007	0,009	0,008
19	0,058	0,053	0,035	0,027	0,031	0,045	0,060	0,075	0,087	0,078	0,074
20	0,006	0,005	0,005	0,005	0,005	0,005	0,006	0,006	0,007	0,008	0,007
21	0,063	0,055	0,035	0,030	0,035	0,049	0,066	0,078	0,088	0,081	0,069
22	0,006	0,005	0,005	0,005	0,005	0,005	0,006	0,006	0,006	0,008	0,008
23	0,065	0,056	0,035	0,032	0,038	0,055	0,068	0,077	0,084	0,076	0,059
24	0,006	0,005	0,004	0,004	0,005	0,005	0,005	0,006	0,006	0,008	0,007
25	0,067	0,054	0,034	0,032	0,039	0,055	0,065	0,074	0,080	0,071	0,055
26	0,006	0,004	0,004	0,004	0,004	0,005	0,005	0,005	0,006	0,007	0,007
27	0,067	0,053	0,035	0,035	0,043	0,057	0,068	0,076	0,079	0,069	0,054
28	0,006	0,005	0,004	0,004	0,005	0,005	0,006	0,006	0,006	0,007	0,008
29	0,065	0,048	0,031	0,032	0,041	0,054	0,065	0,072	0,073	0,062	0,050
30	0,006	0,004	0,004	0,004	0,004	0,005	0,005	0,006	0,006	0,007	0,007
31	0,061	0,047	0,032	0,034	0,042	0,055	0,065	0,069	0,070	0,060	0,048
32	0,007	0,005	0,004	0,004	0,005	0,005	0,005	0,005	0,006	0,007	0,007
33	0,059	0,044	0,031	0,033	0,041	0,055	0,064	0,068	0,068	0,058	0,046
34	0,007	0,004	0,004	0,004	0,005	0,005	0,005	0,006	0,006	0,007	0,007
35	0,051	0,040	0,028	0,030	0,040	0,053	0,062	0,065	0,063	0,053	0,037
36	0,008	0,006	0,005	0,005	0,005	0,005	0,006	0,006	0,006	0,008	0,008
37	0,049	0,038	0,026	0,029	0,038	0,052	0,061	0,063	0,062	0,051	0,035
38	0,008	0,005	0,005	0,005	0,005	0,005	0,006	0,006	0,006	0,007	0,007
39	0,046	0,040	0,029	0,030	0,040	0,054	0,062	0,064	0,062	0,051	0,036
40	0,009	0,007	0,006	0,005	0,006	0,006	0,006	0,006	0,006	0,007	0,008



Interharmonics (HYD 6000-EP)												
P/Pn [%]	0	10	20	30	40	50	60	70	80	90	100	Limit
f [Hz]	I [%In]	I [%In]	I [%In]	I [%In]	I [%In]	I [%In]	I [%In]	I [%In]	I [%In]	I [%In]	I [%In]	I [%In]
75	0,004	0,004	0,004	0,004	0,004	0,004	0,005	0,004	0,006	0,005	0,005	0,40
125	0,003	0,003	0,003	0,003	0,003	0,004	0,004	0,005	0,004	0,006	0,007	0,60
175	0,002	0,002	0,002	0,002	0,002	0,002	0,002	0,003	0,002	0,003	0,003	0,43
225	0,002	0,002	0,002	0,002	0,002	0,002	0,002	0,003	0,002	0,003	0,003	0,33
275	0,002	0,002	0,003	0,004	0,005	0,006	0,006	0,006	0,006	0,006	0,007	0,27
325	0,002	0,002	0,002	0,002	0,002	0,002	0,002	0,002	0,002	0,002	0,003	0,23
375	0,002	0,002	0,002	0,003	0,003	0,003	0,003	0,003	0,003	0,003	0,004	0,20
425	0,005	0,006	0,007	0,012	0,007	0,006	0,018	0,005	0,008	0,009	0,011	0,18
475	0,004	0,004	0,005	0,004	0,005	0,005	0,004	0,005	0,005	0,005	0,004	0,16
525	0,004	0,003	0,004	0,003	0,006	0,009	0,005	0,009	0,009	0,010	0,012	0,14
575	0,003	0,003	0,003	0,003	0,004	0,004	0,003	0,005	0,004	0,004	0,004	0,13
625	0,004	0,005	0,006	0,006	0,006	0,005	0,006	0,005	0,005	0,005	0,004	0,12
675	0,003	0,003	0,003	0,004	0,005	0,006	0,004	0,006	0,006	0,006	0,006	0,11
725	0,002	0,002	0,002	0,002	0,003	0,004	0,003	0,005	0,005	0,006	0,006	0,10
775	0,002	0,002	0,003	0,003	0,003	0,004	0,003	0,005	0,006	0,007	0,007	0,10
825	0,004	0,013	0,016	0,016	0,016	0,011	0,019	0,019	0,025	0,029	0,033	0,09
875	0,002	0,002	0,002	0,002	0,003	0,003	0,003	0,003	0,004	0,004	0,005	0,09
925	0,002	0,002	0,002	0,002	0,002	0,002	0,002	0,003	0,003	0,003	0,003	0,08
975	0,002	0,002	0,002	0,002	0,002	0,002	0,002	0,002	0,002	0,003	0,003	0,08
1025	0,002	0,002	0,002	0,002	0,002	0,002	0,002	0,002	0,002	0,002	0,002	0,07
1075	0,002	0,002	0,002	0,002	0,002	0,002	0,002	0,002	0,002	0,002	0,002	0,07
1125	0,002	0,002	0,002	0,002	0,002	0,002	0,002	0,002	0,002	0,002	0,002	0,07
1175	0,002	0,002	0,002	0,002	0,002	0,002	0,002	0,002	0,002	0,002	0,002	0,06
1225	0,002	0,002	0,002	0,003	0,002	0,002	0,002	0,002	0,003	0,003	0,004	0,06
1275	0,002	0,002	0,002	0,002	0,002	0,002	0,002	0,002	0,002	0,002	0,002	0,06
1325	0,002	0,002	0,002	0,002	0,002	0,002	0,002	0,002	0,002	0,002	0,002	0,06
1375	0,002	0,002	0,002	0,002	0,002	0,002	0,002	0,002	0,002	0,002	0,002	0,05
1425	0,002	0,002	0,002	0,002	0,002	0,002	0,002	0,003	0,003	0,003	0,004	0,05
1475	0,002	0,002	0,002	0,002	0,002	0,002	0,002	0,002	0,002	0,002	0,002	0,05
1525	0,002	0,002	0,002	0,002	0,002	0,002	0,002	0,002	0,002	0,002	0,002	0,05
1575	0,002	0,002	0,002	0,002	0,002	0,002	0,002	0,002	0,003	0,003	0,003	0,05
1625	0,002	0,002	0,002	0,002	0,002	0,002	0,002	0,002	0,002	0,002	0,002	0,05
1675	0,002	0,002	0,002	0,002	0,002	0,002	0,002	0,002	0,002	0,002	0,002	0,04
1725	0,002	0,002	0,002	0,002	0,002	0,002	0,002	0,002	0,002	0,002	0,002	0,04
1775	0,002	0,002	0,002	0,002	0,002	0,002	0,002	0,002	0,002	0,002	0,002	0,04
1825	0,002	0,002	0,002	0,002	0,002	0,002	0,002	0,002	0,002	0,002	0,002	0,04
1875	0,002	0,002	0,002	0,002	0,002	0,002	0,002	0,002	0,002	0,002	0,002	0,04
1925	0,002	0,002	0,002	0,002	0,002	0,002	0,002	0,002	0,002	0,002	0,002	0,04
1975	0,002	0,002	0,002	0,002	0,002	0,002	0,002	0,002	0,002	0,002	0,002	0,04

Higher Frequencies (HYD 6000-EP)												
P/P <sub>n</sub> [%]	0	10	20	30	40	50	60	70	80	90	100	Limit
f [kHz]	I [%In]	I [%In]	I [%In]	I [%In]	I [%In]	I [%In]	I [%In]	I [%In]	I [%In]	I [%In]	I [%In]	I [%In]
2,1	0,004	0,004	0,004	0,004	0,004	0,004	0,004	0,004	0,004	0,004	0,004	0,2
2,3	0,004	0,004	0,004	0,004	0,004	0,004	0,004	0,004	0,004	0,004	0,004	0,2
2,5	0,004	0,004	0,004	0,004	0,004	0,004	0,004	0,004	0,004	0,004	0,004	0,2
2,7	0,004	0,004	0,004	0,004	0,004	0,004	0,004	0,004	0,004	0,004	0,004	0,2
2,9	0,004	0,006	0,008	0,007	0,006	0,005	0,006	0,005	0,006	0,006	0,006	0,2
3,1	0,004	0,006	0,006	0,005	0,005	0,004	0,005	0,005	0,005	0,005	0,005	0,2
3,3	0,004	0,004	0,004	0,004	0,004	0,004	0,004	0,004	0,004	0,004	0,004	0,2
3,5	0,004	0,004	0,005	0,005	0,004	0,004	0,005	0,004	0,005	0,005	0,005	0,2
3,7	0,004	0,005	0,006	0,005	0,005	0,004	0,005	0,005	0,005	0,005	0,005	0,2
3,9	0,004	0,005	0,004	0,004	0,004	0,004	0,004	0,004	0,005	0,005	0,005	0,2
4,1	0,004	0,005	0,005	0,005	0,005	0,004	0,005	0,004	0,005	0,005	0,006	0,2
4,3	0,004	0,005	0,006	0,007	0,005	0,005	0,006	0,005	0,006	0,007	0,007	0,2
4,5	0,005	0,006	0,009	0,009	0,007	0,005	0,007	0,006	0,007	0,007	0,007	0,2
4,7	0,004	0,006	0,007	0,008	0,007	0,005	0,005	0,005	0,006	0,006	0,006	0,2
4,9	0,004	0,004	0,004	0,004	0,004	0,004	0,005	0,004	0,005	0,005	0,005	0,2
5,1	0,004	0,006	0,005	0,006	0,005	0,004	0,005	0,004	0,005	0,005	0,005	0,2
5,3	0,006	0,011	0,016	0,014	0,008	0,006	0,010	0,006	0,010	0,010	0,010	0,2
5,5	0,004	0,005	0,005	0,005	0,004	0,004	0,005	0,004	0,005	0,005	0,005	0,2
5,7	0,006	0,014	0,012	0,016	0,010	0,006	0,010	0,007	0,010	0,010	0,009	0,2
5,9	0,004	0,012	0,010	0,011	0,008	0,005	0,007	0,006	0,008	0,008	0,009	0,2
6,1	0,004	0,004	0,005	0,005	0,004	0,004	0,005	0,005	0,005	0,005	0,005	0,2
6,3	0,004	0,005	0,005	0,006	0,006	0,005	0,005	0,005	0,005	0,005	0,005	0,2
6,5	0,004	0,004	0,005	0,005	0,004	0,004	0,005	0,004	0,005	0,005	0,005	0,2
6,7	0,004	0,004	0,004	0,005	0,004	0,004	0,005	0,005	0,005	0,005	0,005	0,2
6,9	0,004	0,004	0,004	0,005	0,004	0,004	0,005	0,005	0,005	0,005	0,005	0,2
7,1	0,005	0,006	0,007	0,009	0,006	0,005	0,008	0,005	0,007	0,008	0,008	0,2
7,3	0,005	0,006	0,008	0,010	0,006	0,005	0,008	0,005	0,008	0,009	0,009	0,2
7,5	0,004	0,005	0,007	0,008	0,006	0,005	0,007	0,005	0,008	0,008	0,008	0,2
7,7	0,004	0,005	0,005	0,008	0,006	0,005	0,010	0,006	0,011	0,012	0,014	0,2
7,9	0,004	0,005	0,006	0,009	0,007	0,005	0,011	0,006	0,013	0,015	0,016	0,2
8,1	0,004	0,004	0,006	0,008	0,006	0,005	0,011	0,006	0,012	0,014	0,016	0,2
8,3	0,004	0,005	0,005	0,007	0,007	0,005	0,008	0,006	0,010	0,011	0,012	0,2
8,5	0,004	0,005	0,006	0,009	0,011	0,005	0,010	0,010	0,014	0,016	0,017	0,2
8,7	0,004	0,006	0,007	0,010	0,012	0,006	0,008	0,012	0,014	0,015	0,016	0,2
8,9	0,005	0,008	0,013	0,015	0,014	0,008	0,011	0,014	0,017	0,018	0,018	0,2

Note:

The normalization current is 27,3A for HYD 6000-EP.

The tests had been performed on the HYD 6000-EP and HYD 3000-EPs valid for the HYD 5500-EP, HYD 5000-EP, HYD 4600-EP, HYD 4000-EP and HYD 3680-EP, since it is identical in hardware and software construction except output power derated by software.



Report No.: PVDK200917N006-8

# Annex 1

**Pictures of the unit**

**The full pictures refer to PHOTO DOCUMENT**

**Project No.: 200917N016**

**Date: 20210112**

### Enclosure front view



### Enclosure rear view

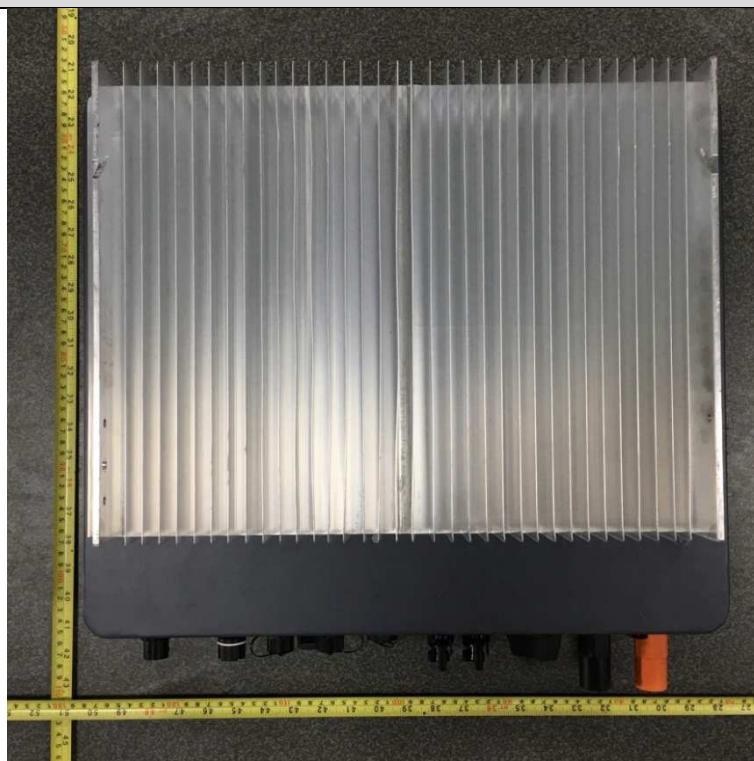

### Enclosure bottom view



### Enclosure side view





Report No.: PVDK200917N006-8

# Annex No. 2

## Test Equipment list

**Test Local: Bureau Veritas Shenzhen Co., Ltd. Dongguan Branch**  
**Dates of performer test: 2020-03-02 to 2021-02-01**

Equipment	Internal No.	Manufacturer	Type	Serial No.	Last Calibration
Power Analyzer	A4080002DG	YOKOGAWA	WT3000	91M210852	Jun. 17, 2020
AC Source	A7040019DG	Chroma	61512	61512000439	Monitored by Power Analyzer
	A7040020DG	Chroma	61512	61512000438	
DC Simulation Power Supply	A7040015DG	Chroma	62150H-1000S	62150EF00488	
	A7040016DG	Chroma	62150H-1000S	62150EF00490	
RLC Load	A7150027DG	Qunling	ACLT-3803H	93VOO2869	
Eight Channel Digital Phosphor Oscilloscope	A4089017DG	YOKOGAWA	DL850	91N726247	Sep. 23, 2020
Four Channel Digital Phosphor Oscilloscope	A4089003DG	Tektronix	DPO4104B	C010624	Mar. 06, 2020
	//	KEYSIGHT	DSOX3014T	MY59243036	Jan. 05, 2021
Oscilloscope probel	A1490009DG	YOKOGAWA	701901	//	Sep. 03, 2020
	A1490010DG	YOKOGAWA	701901	//	Sep. 03, 2020
	A1490011DG	YOKOGAWA	701901	//	Sep. 03, 2020
Current transducer	A1060008DG	YOKOGAWA	CT200	1130700017	Sep. 03, 2020
	A1060009DG	YOKOGAWA	CT200	1130700019	Sep. 03, 2020
	A1060009DG	YOKOGAWA	CT200	1130700019	Sep. 03, 2020